

Product catalogue



KLUG's expertise

With over 140 years of experience, KLUG-CONSERVATION has developed the know-how to produce premium quality products, ensuring maximum permanency for the long-term preservation of cultural assets and modern data carriers for archives, museums, libraries and picture framers. KLUG-CONSERVATION's core area of expertise is the preservation of tangible cultural heritage. An appropriate preservation method respects and preserves, at all times, the intangible value of the cultural artefact.

The close collaboration with clients and cooperation with the paper industry, research institutes, academies and universities promotes the development of improved or innovative new products. This is essential for maintaining a consistently high quality standard, as well as keeping up-to-date with latest developments in the conservation field. This enables us to provide you with the finest products, economical solutions and technical competency which we would like to share with you in our "Technical knowledge folders".

If you have any queries, our team of specialists are happy to assist and advise.



Michael Kuehner



Peter Lang

Information with effect from 1 May 2019.

Quality guarantee

KLUG-CONSERVATION consequently manufactures their ageing resistant paper and board products in accordance with strictly set conservation and preservation regulations and to internationally recognized standards.

We provide each product with a legal binding guarantee certificate on the technological basis of the EN ISO 9706 and ISO 16245 standards. Products made for photographic archival storage have also passed the Photographic Activity Test (PAT).

Each of our products is supplied with a quality guarantee certificate, which legally covers far more than the normal warranty terms, ensuring that the material used meets the requirements for ageing resistance.

For you as our valued customer that means, regardless of any individual tests and results, such as those from independent institutes, e.g. "The Paper Technological Foundation (PTS)", the quality of the product we have supplied strictly meets the requirements stated in the "Quality Guarantee Certificate".



Infinite solutions ...



You can take your pick from our standard range of products, which are based on the modular design concept, or you can choose to let us create a product custom-made for you. You have the idea, we create the solution!

In the case that the product you require is not available in our standard range or all combination possibilities have been exhausted, you can choose to let us develop, together with you, an item that uniquely caters to your preservation requirements. By exclusively using our guaranteed ageing-resistant paper and board materials as a base, we are able to make your unconventional, creative ideas a reality – from a prototype up to large scale production. It will be our pleasure to assist you.

- **Standard assortment:** Products available ex-stock or at short notice (products in this catalogue)
- **Modular design concept:** If you are unable to find the required product in our standard range of products, our modular-based inventory allows for a variety of combination possibilities (e.g. colour, thickness, size, etc.) – Please feel free to make use of our online configurators.
- **Custom-made:** We will create, keeping in mind your ideas, a specialized product that uniquely caters to your requirements. Please do not hesitate to contact us: we will gladly advise you.

Overview of our service benefits



Advisory service

- Free examination of artwork collections/inventories
- Development of customized preservation projects free of charge
- Supervision of complete preservation projects

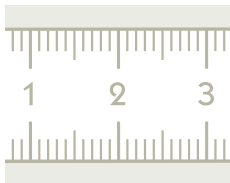

Measuring

- Electronic measuring device to enable exact and quick measuring for two-dimensional (e.g. graphics, photographs etc.) and three-dimensional (e.g. books, files, folders etc.) objects can be supplied free of charge
- On-site measuring service of objects, signatures and titles exact to the millimetre, executed by our trained personnel



Cutting

- Sizes with plus tolerance – max. ± 7 mm
- Rough cuts of formats free of charge for most products for orders of more than 1 packaging unit (formats can be divided into halves, thirds, quarters, sixths, eighths or ninths)
- Fine cuts (e.g. 4-sided angular cut), special and customised formats on request
- Mount/passepartout cutting service

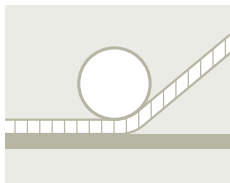

Lamination

- Individual custom-made lamination (modular design concept)
- Various board thicknesses available
- Special colours upon request

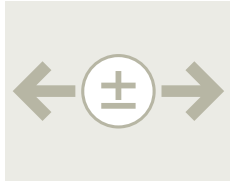

Tolerances

The following production tolerances are to be taken into consideration:

- **Quantity tolerance for paper**
± 3% however a minimum of ± 5 sheets per quantity unit
- **Quantity tolerance for board, corrugated board**
± 3%
- **Quantity tolerance for enclosures, folders, boxes**
± 8%
- **Weight (grammage) tolerance**
± 7%
- **Thickness (calliper) tolerance**
Paper and board up to 300 gsm ± 10%, board > 300 gsm ± 5%, corrugated board ± 8%
- **Dimensional (size) tolerance for paper and board material**
Sizes with plus tolerance – max. ± 7 mm, cutting tolerance 4-sided angular cut ± 2 mm
- **Dimensional (size) tolerance for corrugated board**
Cutting tolerance ± 3 mm
- **Dimensional (size) tolerance for reeled paper**
Roll width ± 5 mm, running metres ± 3%
- **Dimensional (size) tolerance for enclosures, folders, boxes**
Plus tolerance up to 5%
- **Dimensional (size) tolerance for envelope enclosures**
Angle tolerance ± 2 mm, format (size) tolerance ± 3 mm
- **Dimensional (size) tolerance for tubes**
Diameter and tube wall thickness ± 0.3 mm, lengths ± 10 mm
- **Tolerance perpendicularity in case of cuttings with 4-sided angular cut**
Angle tolerance 3% however a minimum of 2 mm for 1 m length
- **pH tolerance**
± 0.5 variation on the pH scale (pH 7, pH 6.5 and 7.5 are also permitted)

Deviating tolerances are to be agreed upon separately.

1. Boards

| | |
|--|----|
| 1.1 Mounting boards | 14 |
| 1.2 Conservation boards | 20 |
| 1.3 Backing boards | 24 |
| 1.4 Archival boards | 25 |
| 1.5 Photographic archival boards | 27 |
| 1.6 Blotting boards | 28 |
| 1.7 Mount/mat configurator | 29 |

2. Corrugated Boards

| | |
|-----------------------------|----|
| 2.1 Corrugated boards | 30 |
|-----------------------------|----|

3. Honeycomb Panel

| | |
|----------------------------|----|
| 3.1 Honeycomb panels | 37 |
|----------------------------|----|

4. Paper

| | |
|---------------------------------------|----|
| 4.1 Archival paper | 38 |
| 4.2 Photographic archival paper | 39 |
| 4.3 Museum paper | 39 |
| 4.4 Japanese paper | 42 |
| 4.5 Silk tissue paper | 43 |
| 4.6 Glassine paper | 45 |
| 4.7 Novo test paper | 46 |

5. Folders

| | |
|---|----|
| 5.1 File folders/drawing portfolios | 47 |
| 5.2 Preservation folders | 48 |
| 5.3 Folders w. filing mechanism | 48 |
| 5.4 Expansion folders | 49 |

6. Enclosures

| | |
|--|----|
| 6.1 Transparent | 59 |
| 6.2 Opaque | 60 |
| 6.3 Binder pocket pages w. binder-edge | 63 |
| 6.4 Envelopes for documents | 64 |
| 6.5 Seal bags | 65 |

7. Boxes

| | |
|--|----|
| 7.1 Wraparound boxes | 66 |
| 7.2 Clamshell boxes | 68 |
| 7.3 Slipcases | 80 |
| 7.4 Slipcases with shelf file | 81 |
| 7.5 Shelf files | 82 |
| 7.6 Archival boxes | 83 |
| 7.7 Two-piece boxes | 90 |
| 7.8 Folded boxes for film reel storage | 95 |
| 7.9 Box configurator | 96 |

8. Tubes

| | |
|--|----|
| 8.1 Tubes made from conservation board | 97 |
|--|----|

9. Glues/Tapes

| | |
|-----------------|----|
| 9.1 Glues | 98 |
| 9.2 Tapes | 99 |

10. Accessories

| | |
|--------------------------------------|-----|
| 10.1 Label paper | 100 |
| 10.2 Label signatures | 101 |
| 10.3 Label frames | 102 |
| 10.4 Mounting accessories | 103 |
| 10.5 Polyester nonwoven fabric | 104 |
| 10.6 Filing mechanism | 104 |
| 10.7 Albertina poultice | 105 |
| 10.8 Panduran pen | 105 |

11. Boxing System

| | |
|--------------------------|-----|
| 11.1 Boxing system | 106 |
|--------------------------|-----|

1. Boards

1.1 Mounting boards

H Variety – white

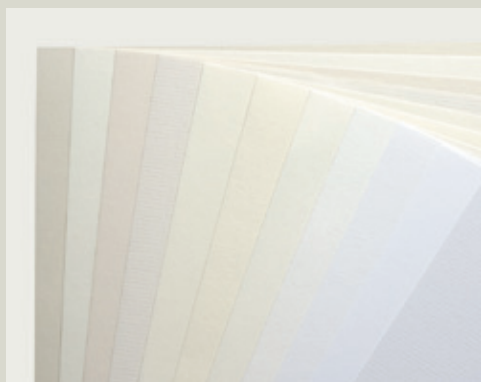

An economically priced mounting board for conservation-quality picture framing, mounting, displays and exhibits. Top surface available in various white shades with high light-fastness, surface structure vellum or ribbed. Base board in white.

Cuttings: Rough cuts of formats free of charge for orders > 1 packaging unit (formats can be divided into halves, thirds, quarters, sixths, eighths or ninths), other sizes on request.

Please note: The illustrated top surface colours and structures match the actual products approximately. For exact colour and surface structure please request for single samples.

| Item | Thickness (mm) | Size (cm) | Weight (gsm) | Shts./unit | Colour (top surface in white shades/base board white) |
|-------|----------------|-----------|--------------|------------|---|
| 10162 | 1.6 | 80 x 100 | 1140 | 10 | H10 porcelain, ribbed |
| 10163 | 1.6 | 100 x 140 | 1140 | 10 | H10 porcelain, ribbed |
| 10212 | 2.1 | 80 x 100 | 1635 | 10 | H10 porcelain, ribbed |
| 10213 | 2.1 | 100 x 140 | 1635 | 10 | H10 porcelain, ribbed |
| 10302 | 3.1 | 80 x 100 | 2250 | 10 | H10 porcelain, ribbed |
| 10303 | 3.1 | 100 x 140 | 2250 | 5 | H10 porcelain, ribbed |
| 11162 | 1.6 | 80 x 100 | 1140 | 10 | H11 pure white, ribbed |
| 11163 | 1.6 | 100 x 140 | 1140 | 10 | H11 pure white, ribbed |
| 11212 | 2.1 | 80 x 100 | 1635 | 10 | H11 pure white, ribbed |
| 11213 | 2.1 | 100 x 140 | 1635 | 10 | H11 pure white, ribbed |
| 11302 | 3.1 | 80 x 100 | 2250 | 10 | H11 pure white, ribbed |
| 11303 | 3.1 | 100 x 140 | 2250 | 5 | H11 pure white, ribbed |
| 12162 | 1.6 | 80 x 100 | 1140 | 10 | H12 powder, ribbed |
| 12163 | 1.6 | 100 x 140 | 1140 | 10 | H12 powder, ribbed |
| 12212 | 2.1 | 80 x 100 | 1635 | 10 | H12 powder, ribbed |
| 12213 | 2.1 | 100 x 140 | 1635 | 10 | H12 powder, ribbed |
| 12302 | 3.1 | 80 x 100 | 2250 | 10 | H12 powder, ribbed |
| 12303 | 3.1 | 100 x 140 | 2250 | 5 | H12 powder, ribbed |
| 13162 | 1.6 | 80 x 100 | 1140 | 10 | H13 chamois, vellum |
| 13163 | 1.6 | 100 x 140 | 1140 | 10 | H13 chamois, vellum |
| 13212 | 2.1 | 80 x 100 | 1635 | 10 | H13 chamois, vellum |
| 13213 | 2.1 | 100 x 140 | 1635 | 10 | H13 chamois, vellum |
| 13302 | 3.1 | 80 x 100 | 2250 | 10 | H13 chamois, vellum |
| 13303 | 3.1 | 100 x 140 | 2250 | 5 | H13 chamois, vellum |
| 14162 | 1.6 | 80 x 100 | 1140 | 10 | H14 ivory, vellum |
| 14163 | 1.6 | 100 x 140 | 1140 | 10 | H14 ivory, vellum |
| 14212 | 2.1 | 80 x 100 | 1635 | 10 | H14 ivory, vellum |
| 14213 | 2.1 | 100 x 140 | 1635 | 10 | H14 ivory, vellum |

Shts. = sheets ; unit = packaging unit ; ¹⁾ cuttings to size, extra cost ; ²⁾ cuttings not possible ; ³⁾ without 4-sided angular cut ; ⁴⁾ units packed in poly bags ; ⁵⁾ extra cost for freight & packaging

1. Boards

1.1 Mounting boards

H Variety – white

| Item | Thickness (mm) | Size (cm) | Weight (gsm) | Shts./unit | Colour (top surface in white shades/base board white) |
|-------|----------------|-----------|--------------|------------|---|
| 14301 | 3.1 | 70 x 100 | 2250 | 10 | H14 ivory, vellum |
| 14302 | 3.1 | 80 x 100 | 2250 | 10 | H14 ivory, vellum |
| 14303 | 3.1 | 100 x 140 | 2250 | 5 | H14 ivory, vellum |
| 21161 | 1.6 | 70 x 100 | 1140 | 20 | H21 lucid white, ribbed |
| 21162 | 1.6 | 80 x 100 | 1140 | 10 | H21 lucid white, ribbed |
| 21163 | 1.6 | 100 x 140 | 1140 | 10 | H21 lucid white, ribbed |
| 21211 | 2.1 | 70 x 100 | 1635 | 10 | H21 lucid white, ribbed |
| 21212 | 2.1 | 80 x 100 | 1635 | 10 | H21 lucid white, ribbed |
| 21213 | 2.1 | 100 x 140 | 1635 | 10 | H21 lucid white, ribbed |
| 21301 | 3.1 | 70 x 100 | 2250 | 10 | H21 lucid white, ribbed |
| 21312 | 3.1 | 80 x 100 | 2250 | 10 | H21 lucid white, ribbed |
| 21303 | 3.1 | 100 x 140 | 2250 | 5 | H21 lucid white, ribbed |
| 20162 | 1.6 | 80 x 100 | 1140 | 20 | H20 snow white, vellum |
| 20163 | 1.6 | 100 x 140 | 1140 | 10 | H20 snow white, vellum |
| 20212 | 2.1 | 80 x 100 | 1635 | 20 | H20 snow white, vellum |
| 20213 | 2.1 | 100 x 140 | 1635 | 10 | H20 snow white, vellum |
| 20312 | 3.1 | 80 x 100 | 2250 | 20 | H20 snow white, vellum |
| 20303 | 3.1 | 100 x 140 | 2250 | 5 | H20 snow white, vellum |
| 22162 | 1.6 | 80 x 100 | 1140 | 20 | H22 white, vellum |
| 22212 | 2.1 | 80 x 100 | 1635 | 20 | H22 white, vellum |
| 22312 | 3.1 | 80 x 100 | 2250 | 20 | H22 white, vellum |
| 23162 | 1.6 | 80 x 100 | 1140 | 20 | H23 yellowish, vellum |
| 23212 | 2.1 | 80 x 100 | 1635 | 20 | H23 yellowish, vellum |
| 23312 | 3.1 | 80 x 100 | 2250 | 20 | H23 yellowish, vellum |
| 25162 | 1.6 | 80 x 100 | 1140 | 20 | H25 white, ribbed |
| 25212 | 2.1 | 80 x 100 | 1635 | 20 | H25 white, ribbed |
| 25312 | 3.1 | 80 x 100 | 2250 | 20 | H25 white, ribbed |

Shts. = sheets ; unit = packaging unit ; ¹⁾ cuttings to size, extra cost ; ²⁾ cuttings not possible ; ³⁾ without 4-sided angular cut ; ⁴⁾ units packed in poly bags ; ⁵⁾ extra cost for freight & packaging

1. Boards

1.1 Mounting boards

H Variety – black

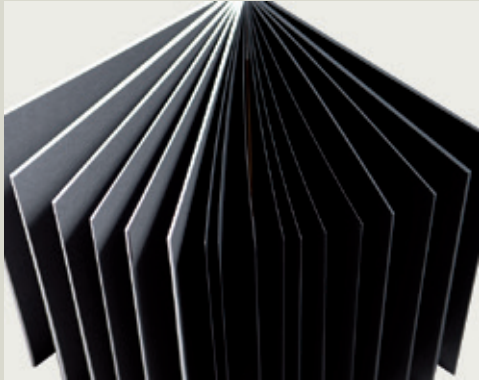

An economically priced, top quality black mounting board with excellent diagonal cutting characteristics, exceptional for conservation-quality framing, mounting, displays and exhibits. All qualities possess high light-fastness, base board available either in black or white.

Cuttings: Rough cuts of formats free of charge for orders > 1 packaging unit (formats can be divided into halves, thirds, quarters, sixths, eighths or ninths), other sizes on request.

| Item | Thickness (mm) | Size (cm) | Weight (gsm) | Shts./unit | Colour (top ply/base board) |
|---|----------------|-----------|--------------|------------|-----------------------------|
| <i>H17, top surface black, base board black</i> | | | | | |
| 17162 | 1.6 | 80 x 100 | 1140 | 10 | black, ribbed/black |
| 17203 | 2.1 | 80 x 100 | 1635 | 10 | black, ribbed/black |
| 17303 | 3.1 | 80 x 100 | 2250 | 10 | black, ribbed/black |
| <i>H68, top surface black, base board white</i> | | | | | |
| 68162 | 1.6 | 80 x 100 | 1140 | 20 | black, ribbed/white |
| 68212 | 2.1 | 80 x 100 | 1635 | 10 | black, ribbed/white |
| 68303 | 3.1 | 80 x 100 | 2250 | 10 | black, ribbed/white |
| | | | | | |
| | | | | | |
| | | | | | |
| | | | | | |
| | | | | | |
| | | | | | |
| | | | | | |
| | | | | | |
| | | | | | |
| | | | | | |
| | | | | | |
| | | | | | |
| | | | | | |
| | | | | | |
| | | | | | |
| | | | | | |
| | | | | | |
| | | | | | |
| | | | | | |
| | | | | | |
| | | | | | |
| | | | | | |
| | | | | | |
| | | | | | |
| | | | | | |
| | | | | | |

Shts. = sheets ; unit = packaging unit ; ¹⁾ cuttings to size, extra cost ; ²⁾ cuttings not possible ; ³⁾ without 4-sided angular cut ; ⁴⁾ units packed in poly bags ; ⁵⁾ extra cost for freight & packaging

1. Boards

1.1 Mounting boards

015 – light white



An economically priced, light white solid colour (dyed throughout) mounting board ideal for conservation-quality picture framing and mounting, displays and museum exhibits. Also available in oversize (182 x 252 cm).

Cuttings: Rough cuts of formats free of charge for orders > 1 packaging unit (formats can be divided into halves, thirds, quarters, sixths, eighths or ninths), other sizes on request.

| Item | Thickness (mm) | Size (cm) | Weight (gsm) | Shts./unit | Colour |
|----------|----------------|----------------------------|--------------|-----------------|-------------|
| 015075/5 | 0.75 | 84 x 124 | 550 | 25 | light white |
| 015075/7 | 0.75 | 124 x 144 | 550 | 20 | light white |
| 01515/7 | 1.5 | 124 x 144 | 1130 | 10 | light white |
| 01526/8 | 2.6 | 182 x 252 ^{1) 5)} | 1955 | 3 ⁴⁾ | light white |
| 01530/7 | 3.0 | 124 x 144 | 2200 | 10 | light white |

Shts. = sheets ; unit = packaging unit ; ¹⁾ cuttings to size, extra cost ; ²⁾ cuttings not possible ; ³⁾ without 4-sided angular cut ; ⁴⁾ units packed in poly bags ; ⁵⁾ extra cost for freight & packaging

1. Boards

1.1 Mounting boards

018 – white



An economically priced, white solid colour (dyed throughout) mounting board with excellent diagonal cutting characteristics. Ideal for conservation-quality picture framing and mounting, displays and museum exhibits.

Cuttings: Rough cuts of formats free of charge for orders > 1 packaging unit (formats can be divided into halves, thirds, quarters, sixths, eighths or ninths), other sizes on request.

| Item | Thickness (mm) | Size (cm) | Weight (gsm) | Shts./unit | Colour |
|----------|----------------|----------------------------|--------------|------------|--------|
| 018905 | 0.5 | 100 x 140 | 365 | 50 | white |
| 018910/1 | 1.0 | 80 x 100 | 750 | 25 | white |
| 018910 | 1.0 | 100 x 160 | 750 | 25 | white |
| 018915/1 | 1.5 | 80 x 100 | 1130 | 20 | white |
| 018915/2 | 1.5 | 100 x 140 | 1130 | 10 | white |
| 018920/1 | 2.0 | 80 x 100 | 1510 | 10 | white |
| 018920/2 | 2.0 | 100 x 140 | 1510 | 10 | white |
| 018925/2 | 2.5 | 100 x 140 | 1895 | 10 | white |
| 018930/1 | 3.0 | 100 x 140 | 2100 | 10 | white |
| 018930/2 | 3.0 | 100 x 140 | 2100 | 10 | white |
| 018940/1 | 4.0 | 80 x 100 ^{2) 3)} | 3040 | 10 | white |
| 018940/2 | 4.0 | 100 x 140 ^{2) 3)} | 3040 | 5 | white |
| | | | | | |
| | | | | | |
| | | | | | |
| | | | | | |
| | | | | | |
| | | | | | |
| | | | | | |
| | | | | | |
| | | | | | |
| | | | | | |
| | | | | | |
| | | | | | |
| | | | | | |
| | | | | | |
| | | | | | |
| | | | | | |
| | | | | | |

Shts. = sheets ; unit = packaging unit ; ¹⁾ cuttings to size, extra cost ; ²⁾ cuttings not possible ; ³⁾ without 4-sided angular cut ; ⁴⁾ units packed in poly bags ; ⁵⁾ extra cost for freight & packaging

1. Boards

1.1 Mounting boards

019 – natural white/white



An economically priced mounting board, natural white/white in colour with excellent diagonal cutting characteristics. Ideal for conservation-quality picture framing and mounting, displays and museum exhibits.

Cuttings: Rough cuts of formats free of charge for orders > 1 packaging unit (formats can be divided into halves, thirds, quarters, sixths, eighths or ninths), other sizes on request.

| Item | Thickness (mm) | Size (cm) | Weight (gsm) | Shts./unit | Colour |
|---------|----------------|---------------------------|--------------|------------|---------------------|
| 01915/1 | 1.5 | 80 x 100 | 1130 | 20 | natural white/white |
| 01915 | 1.5 | 100 x 160 | 1130 | 10 | natural white/white |
| 01920/1 | 2.0 | 80 x 100 | 1510 | 10 | natural white/white |
| 01920/2 | 2.0 | 100 x 140 | 1510 | 10 | natural white/white |
| 01920 | 2.0 | 100 x 160 | 1510 | 10 | natural white/white |
| 01922 | 2.0 | 126.5 x 180 ⁵⁾ | 1510 | 5 | natural white/white |
| 01925/1 | 2.5 | 80 x 100 | 1900 | 10 | natural white/white |
| 01925 | 2.5 | 100 x 160 | 1900 | 10 | natural white/white |
| 01930/1 | 3.0 | 80 x 100 | 2100 | 10 | natural white/white |
| 01930 | 3.0 | 100 x 160 | 2100 | 5 | natural white/white |
| 01940/2 | 4.0 | 100 x 140 ²⁾³⁾ | 3040 | 10 | natural white/white |
| | | | | | |
| | | | | | |
| | | | | | |
| | | | | | |
| | | | | | |
| | | | | | |
| | | | | | |
| | | | | | |
| | | | | | |
| | | | | | |
| | | | | | |
| | | | | | |
| | | | | | |
| | | | | | |
| | | | | | |
| | | | | | |
| | | | | | |

Shts. = sheets ; unit = packaging unit ; ¹⁾ cuttings to size, extra cost ; ²⁾ cuttings not possible ; ³⁾ without 4-sided angular cut ; ⁴⁾ units packed in poly bags ; ⁵⁾ extra cost for freight & packaging

1. Boards

1.2 Conservation boards

017 ES – natural white

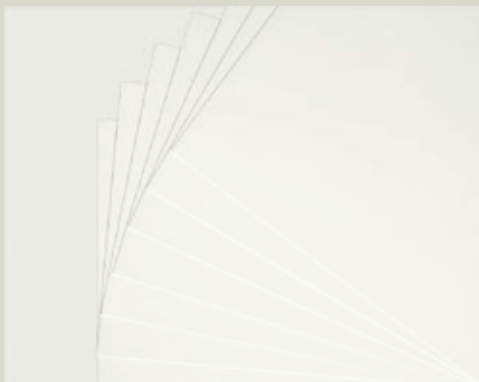

An inexpensive, natural white, solid colour (dyed throughout) conservation board manufactured in ES-quality (1.0 – 3.0 mm thickness), possessing excellent diagonal cutting characteristics. Ideal for conservation-quality picture framing and mounting, displays and museum exhibits. The board is free of optical brightening agents and has passed the Photographic Activity Test (PAT) in accordance with ISO 18916.

Cuttings: Rough cuts of formats free of charge for orders > 1 packaging unit (formats can be divided into halves, thirds, quarters, sixths, eighths or ninths), other sizes on request.

| Item | ES | Thickness (mm) | Size (cm) | Weight (gsm) | Shts./unit | Colour |
|---------|----|----------------|---------------------------|--------------|-----------------|---------------|
| 01705/1 | | 0.5 | 80 x 100 | 365 | 50 | natural white |
| 01705 | | 0.5 | 100 x 160 | 365 | 25 | natural white |
| 01705/3 | | 0.5 | 100 x 172 | 365 | 25 | natural white |
| 01710/1 | ✓ | 1.0 | 81 x 121 | 770 | 20 | natural white |
| 01710/2 | ✓ | 1.0 | 100 x 140 | 770 | 25 | natural white |
| 01715/1 | ✓ | 1.5 | 81 x 121 | 1130 | 15 | natural white |
| 01715/2 | ✓ | 1.5 | 100 x 140 | 1130 | 10 | natural white |
| 01720/1 | ✓ | 2.0 | 80 x 120 | 1520 | 10 | natural white |
| 01720/2 | ✓ | 2.0 | 100 x 140 | 1520 | 10 | natural white |
| 01725/1 | ✓ | 2.5 | 80 x 120 | 1895 | 10 | natural white |
| 01725/2 | ✓ | 2.5 | 100 x 140 | 1895 | 10 | natural white |
| 01726/8 | | 2.6 | 182 x 252 ¹⁾⁵⁾ | 1955 | 3 ⁴⁾ | natural white |
| 01730/1 | ✓ | 3.0 | 80 x 120 | 2310 | 10 | natural white |
| 01730/7 | | 3.0 | 124 x 144 | 2310 | 10 | natural white |
| | | | | | | |
| | | | | | | |
| | | | | | | |
| | | | | | | |
| | | | | | | |
| | | | | | | |
| | | | | | | |
| | | | | | | |
| | | | | | | |
| | | | | | | |
| | | | | | | |
| | | | | | | |

Shts. = sheets ; unit = packaging unit ; ¹⁾ cuttings to size, extra cost ; ²⁾ cuttings not possible ; ³⁾ without 4-sided angular cut ; ⁴⁾ units packed in poly bags ; ⁵⁾ extra cost for freight & packaging ; ES = lamination of multiple-ply board with an emission-free adhesive

1. Boards

1.2 Conservation boards

084 ES – cream



A compact and sturdy cream, solid colour (dyed throughout) conservation board manufactured in ES-quality, possessing excellent diagonal cutting characteristics. Ideal for conservation-quality picture framing and mounting, displays and museum exhibits. The board is free of optical brightening agents and has passed the Photographic Activity Test (PAT) in accordance with the ISO 18916.

Cuttings: Rough cuts of formats free of charge for orders > 1 packaging unit (formats can be divided into halves, thirds, quarters, sixths, eighths or ninths), other sizes on request.

| Item | ES | Thickness (mm) | Size (cm) | Weight (gsm) | Shts./unit ⁴⁾ | Colour |
|----------|----|----------------|-----------|--------------|--------------------------|--------|
| 0841x | | 0.15 | 70 x 100 | 135 | 100 | cream |
| 0843 | | 0.3 | 100 x 140 | 225 | 50 | cream |
| 0845 | | 0.5 | 100 x 140 | 345 | 50 | cream |
| 08418/1 | ✓ | 1.0 | 100 x 140 | 710 | 15 | cream |
| 08418/15 | ✓ | 1.5 | 100 x 140 | 1080 | 10 | cream |
| 08418/3 | ✓ | 2.0 | 100 x 140 | 1520 | 10 | cream |
| 08418/6 | ✓ | 2.5 | 100 x 140 | 1855 | 10 | cream |
| 08418/4 | ✓ | 3.0 | 100 x 140 | 2200 | 5 | cream |
| | | | | | | |
| | | | | | | |
| | | | | | | |
| | | | | | | |
| | | | | | | |
| | | | | | | |
| | | | | | | |
| | | | | | | |
| | | | | | | |
| | | | | | | |
| | | | | | | |
| | | | | | | |
| | | | | | | |
| | | | | | | |
| | | | | | | |
| | | | | | | |
| | | | | | | |
| | | | | | | |
| | | | | | | |
| | | | | | | |
| | | | | | | |

Shts. = sheets ; unit = packaging unit ; ¹⁾ cuttings to size, extra cost ; ²⁾ cuttings not possible ; ³⁾ without 4-sided angular cut ; ⁴⁾ units packed in poly bags ; ⁵⁾ extra cost for freight & packaging ; ES = lamination of multiple-ply board with an emission-free adhesive

1. Boards

1.2 Conservation boards

086 – ivory



A compact and sturdy ivory solid colour (dyed throughout) conservation board possessing excellent diagonal cutting characteristics. Ideal for conservation-quality picture framing and mounting, displays and museum exhibits. The board is free of optical brightening agents and has passed the Photographic Activity Test (PAT) in accordance with the ISO 18916.

Cuttings: Rough cuts of formats free of charge for orders > 1 packaging unit (formats can be divided into halves, thirds, quarters, sixths, eighths or ninths), other sizes on request.

| Item | Thickness (mm) | Size (cm) | Weight (gsm) | Shts./unit ⁴⁾ | Colour |
|----------|----------------|-----------|--------------|--------------------------|--------|
| 086805/2 | 0.5 | 100 x 140 | 340 | 50 | ivory |
| 086825/2 | 2.5 | 100 x 140 | 1855 | 10 | ivory |
| 086830/2 | 3.0 | 100 x 140 | 2170 | 5 | ivory |
| | | | | | |
| | | | | | |

1.2 Conservation boards

012 ES – chamois/natural white

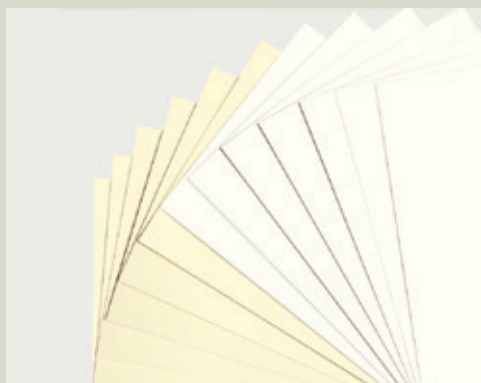

A hard and rigid board available in solid natural white or chamois/natural white in ES-quality, specially suitable for graphic collections.

Top surface specially treated thus dirt-resistant, erasable and rub-proof (dry wiping). The board is free of optical brightening agents and has passed the Photographic Activity Test (PAT) in accordance with ISO 18916.

Cuttings: Rough cuts of formats free of charge for orders > 1 packaging unit (formats can be divided into halves, thirds, quarters, sixths, eighths or ninths), other sizes on request.

| Item | ES | Thickness (mm) | Size (cm) | Weight (gsm) | Shts./unit ⁴⁾ | Colour |
|---------|----|----------------|-----------|--------------|--------------------------|-----------------------|
| 012421 | | 0.3 | 100 x 140 | 280 | 50 | natural white |
| 0124221 | | 0.6 | 100 x 140 | 580 | 25 | natural white |
| 012422 | ✓ | 0.6 | 100 x 140 | 580 | 25 | chamois/natural white |
| 012426 | ✓ | 1.8 | 100 x 140 | 1780 | 10 | chamois/natural white |
| | | | | | | |
| | | | | | | |

Shts. = sheets ; unit = packaging unit ; ¹⁾ cuttings to size, extra cost ; ²⁾ cuttings not possible ; ³⁾ without 4-sided angular cut ; ⁴⁾ units packed in poly bags ; ⁵⁾ extra cost for freight & packaging ; ES = lamination of multiple-ply board with an emission-free adhesive

1. Boards

1.2 Conservation board

013 – cream/natural white

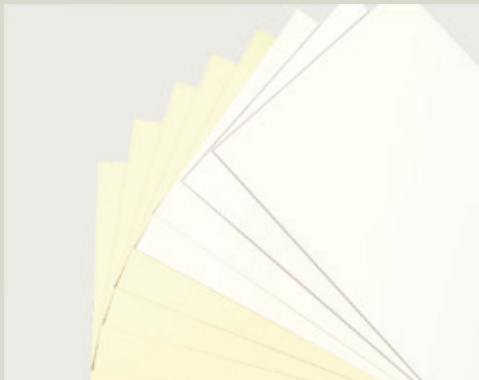

An economically priced matting and backing board, exceptional for conservation-quality picture framing and mounting. Available in solid cream or with top ply in cream and base board in natural white. Top surface specially treated thus dirt-resistant, erasable and rub-proof (dry wiping). The board is free of optical brightening agents and has passed the Photographic Activity Test (PAT) in accordance with ISO 18916.

Cuttings: Rough cuts of formats free of charge for orders > 1 packaging unit (formats can be divided into halves, thirds, quarters, sixths, eighths or ninths), other sizes on request.

| Item | Thickness (mm) | Size (cm) | Weight (gsm) | Shts./unit | Colour |
|---------|----------------|-----------|--------------|------------|---------------------|
| 01303/2 | 0.3 | 100 x 140 | 250 | 50 | cream |
| 013166 | 1.8 | 100 x 140 | 1410 | 10 | cream/natural white |
| | | | | | |
| | | | | | |
| | | | | | |
| | | | | | |

1.2 Conservation boards

014 ES – chamois

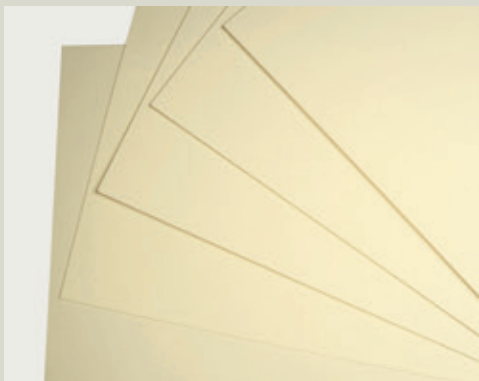

A very hard and rigid chamois solid colour (dyed throughout) conservation board in ES-quality, specially suitable for graphic collections in frequent use. Top surface specially treated thus dirt-resistant, erasable and rub-proof (dry wiping). The board is free of optical brightening agents and has passed the Photographic Activity Test (PAT) in accordance with ISO 18916.

Cuttings: Rough cuts of formats free of charge for orders > 1 packaging unit (formats can be divided into halves, thirds, quarters, sixths, eighths or ninths), other sizes on request.

| Item | ES | Thickness (mm) | Size (cm) | Weight (gsm) | Shts./unit ⁴⁾ | Colour |
|--------|----|----------------|-----------|--------------|--------------------------|---------|
| 014161 | | 0.3 | 100 x 140 | 280 | 50 | chamois |
| 014162 | ✓ | 0.6 | 100 x 140 | 580 | 25 | chamois |
| 014163 | ✓ | 0.9 | 100 x 140 | 880 | 25 | chamois |
| 014164 | ✓ | 1.2 | 100 x 140 | 1180 | 10 | chamois |
| 014166 | ✓ | 1.8 | 100 x 140 | 1780 | 10 | chamois |
| | | | | | | |

Shts. = sheets ; unit = packaging unit ; ¹⁾ cuttings to size, extra cost ; ²⁾ cuttings not possible ; ³⁾ without 4-sided angular cut ; ⁴⁾ units packed in poly bags ; ⁵⁾ extra cost for freight & packaging ; ES = lamination of multiple-ply board with an emission-free adhesive

1. Boards

1.2 Conservation boards

050 – black



A compact and very hard, black coloured (dyed throughout) board ideal for conservation-quality picture framing and mounting. The board has high abrasion resistance and is extremely light-fast (approx. 7 – 8 in accordance with the wool scale). The board is dyed evenly solid black and has passed the Photographic Activity Test (PAT) in accordance with ISO 18916.

Cuttings: Rough cuts of formats free of charge for orders > 1 packaging unit (formats can be divided into halves, thirds, quarters, sixths, eighths or ninths), other sizes on request.

| Item | Thickness (mm) | Size (cm) | Weight (gsm) | Shts./unit | Colour |
|---------|----------------|-----------|--------------|------------|--------|
| 050050 | 0.5 | 80 x 120 | 360 | 40 | black |
| 05015/4 | 1.5 | 80 x 120 | 1130 | 20 | black |
| 05030/4 | 3.0 | 80 x 120 | 2200 | 10 | black |
| | | | | | |
| | | | | | |

1.3 Backing boards

07 – natural white/grey-blue
grey-blue/white/grey-blue

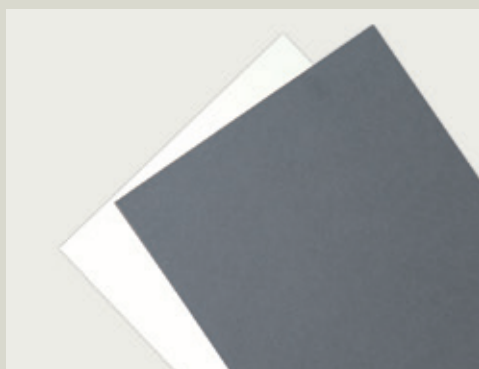

An economically priced backing board in natural white/grey-blue and grey-blue/white/grey-blue, specially developed for conservation-quality picture framing and mounting. The board is free of optical brightening agents and has passed the Photographic Activity Test (PAT) in accordance with ISO 18916.

Cuttings: Rough cuts of formats free of charge for orders > 1 packaging unit (formats can be divided into halves, thirds, quarters, sixths, eighths or ninths), other sizes on request.

| Item | Thickness (mm) | Size ¹⁾ (cm) | Weight (gsm) | Shts./unit | Colour |
|-----------|----------------|-------------------------|--------------|------------|---------------------------|
| 0747270 | 2.7 | 101 x 141 | 1810 | 5 | natural white/grey-blue |
| 074477270 | 2.7 | 101 x 141 | 1810 | 5 | grey-blue/white/grey-blue |
| | | | | | |
| | | | | | |

Shts. = sheets ; unit = packaging unit ; ¹⁾ cuttings to size, extra cost ; ²⁾ cuttings not possible ; ³⁾ without 4-sided angular cut ; ⁴⁾ units packed in poly bags ; ⁵⁾ extra cost for freight & packaging

1. Boards

1.4 Archival boards

047 – grey-blue



A grey-blue, solid colour (dyed throughout) board with a specially treated top surface, dirt-resistant, erasable and rub-proof (dry wiping). Excellent grooving/creasing characteristics due to high long-fibre content. The board is free of optical brightening agents and has passed the Photographic Activity Test (PAT) in accordance with ISO 18916. **Cuttings:** Rough cuts of formats free of charge for orders > 1 packaging unit (formats can be divided into halves, thirds, quarters, sixths, eighths or ninths), other sizes on request.

| Item | Weight (gsm) | Size (cm) | Thickness (mm) | Grain | Shts./unit | Colour |
|----------|--------------|-----------|----------------|-------------|------------|-----------|
| 04718513 | 185 | 100 x 140 | 0.21 | long grain | 50 | grey-blue |
| 04724011 | 240 | 70x 100 | 0.25 | long grain | 50 | grey-blue |
| 04724012 | 240 | 90 x 120 | 0.25 | long grain | 25 | grey-blue |
| 04724013 | 240 | 100 x 140 | 0,25 | long grain | 25 | grey-blue |
| 04731 | 330 | 100 x 70 | 0.35 | short grain | 50 | grey-blue |
| 04732 | 330 | 90 x 120 | 0.35 | long grain | 25 | grey-blue |
| 04733 | 330 | 100 x 140 | 0.35 | long grain | 25 | grey-blue |

1.4 Archival boards

04799 – grey-blue/natural white



Archival board, grey-blue/natural white with a soft core and specially treated top surface, dirt-resistant, erasable and rub-proof. Excellent grooving and punching characteristics due to balanced transverse-longitudinal grain direction and high long-fibre content. Ideal as boxboard material for the manufacture of archival folders and boxes of high material thicknesses. The board is OBA-free and has passed the Photographic Activity Test (PAT) in accordance with ISO 18916. **Cuttings:** Rough cuts of formats free of charge for orders of more than 1 packaging unit, other sizes on request.

| Item | Thickness (mm) | Size (cm) | Weight (gsm) | Shts./unit | Colour |
|------------|----------------|-----------|--------------|------------|-------------------------|
| 04799065 | 0.7 | 101 x 141 | 550 | 20 | grey-blue/natural white |
| 04799065/3 | 0.7 | 100 x 172 | 550 | 20 | grey-blue/natural white |
| 04799090 | 0.9 | 101 x 141 | 670 | 15 | grey-blue/natural white |
| 04799130 | 1.3 | 101 x 141 | 955 | 10 | grey-blue/natural white |
| 04799150 | 1.5 | 101 x 141 | 1070 | 10 | grey-blue/natural white |
| 04799170 | 1.7 | 101 x 141 | 1190 | 10 | grey-blue/natural white |
| 04799190 | 1.9 | 101 x 141 | 1310 | 7 | grey-blue/natural white |

Shts. = sheets ; unit = packaging unit ; ¹⁾ cuttings to size, extra cost ; ²⁾ cuttings not possible ; ³⁾ without 4-sided angular cut ; ⁴⁾ units packed in poly bags ; ⁵⁾ extra cost for freight & packaging

1. Boards

1.4 Archival boards

048 – light grey



A light grey, solid colour (dyed throughout) board with a specially treated top surface, dirt-resistant, erasable and rub-proof (dry wiping). Excellent grooving/creasing characteristics due to high long-fibre content.

The board is free of optical brightening agents and has passed the Photographic Activity Test (PAT) in accordance with ISO 18916.

Cuttings: Rough cuts of formats free of charge for orders > 1 packaging unit (formats can be divided into halves, thirds, quarters, sixths, eighths or ninths), other sizes on request.

| Item | Weight (gsm) | Size (cm) | Thickness (mm) | Grain | Shts./unit | Colour |
|--------|--------------|-----------|----------------|-----------------|------------|------------|
| 04811 | 240 | 70 x 100 | 0.25 | alternate grain | 50 | light grey |
| 04812 | 240 | 90 x 120 | 0.25 | long grain | 25 | light grey |
| 04813 | 240 | 100 x 140 | 0.25 | long grain | 25 | light grey |
| 04831 | 330 | 70 x 100 | 0.35 | alternate grain | 50 | light grey |
| 04832 | 330 | 90 x 120 | 0.35 | long grain | 25 | light grey |
| 04833 | 330 | 100 x 140 | 0.35 | long grain | 25 | light grey |
| 048400 | 400 | 172 x 122 | 0.44 | short grain | 20 | light grey |
| 048450 | 450 | 100 x 140 | 0.48 | long grain | 25 | light grey |
| 04822 | 530 | 90 x 120 | 0.55 | long grain | 25 | light grey |
| 04821 | 530 | 100 x 70 | 0.55 | short grain | 50 | light grey |
| 04823 | 530 | 100 x 140 | 0.55 | long grain | 25 | light grey |
| | | | | | | |
| | | | | | | |
| | | | | | | |
| | | | | | | |
| | | | | | | |
| | | | | | | |
| | | | | | | |
| | | | | | | |
| | | | | | | |
| | | | | | | |
| | | | | | | |
| | | | | | | |
| | | | | | | |
| | | | | | | |
| | | | | | | |
| | | | | | | |

Shts. = sheets ; unit = packaging unit ; ¹⁾ cuttings to size, extra cost ; ²⁾ cuttings not possible ; ³⁾ without 4-sided angular cut ; ⁴⁾ units packed in poly bags ; ⁵⁾ extra cost for freight & packaging

1. Boards

1.4 Archival boards

049 – beige-taupe



A beige-taupe, solid colour (dyed throughout) board with a specially treated top surface, dirt-resistant, erasable and rub-proof (dry wiping). Excellent grooving characteristic due to high long-fibre content. The board is free of optical brightening agents and has passed the Photographic Activity Test (PAT) in accordance with ISO 18916.

Cuttings: Rough cuts of formats free of charge for orders > 1 packaging unit (formats can be divided into halves, thirds, quarters, sixths, eighths or ninths), other sizes on request.

| Item | Weight (gsm) | Size (cm) | Thickness (mm) | Grain | Shts./unit | Colour |
|-----------|--------------|-----------|----------------|-------------|------------|-------------|
| 049/170SB | 170 | 80 x 120 | 0.2 | long grain | 125 | beige-taupe |
| 049/170BB | 170 | 120 x 80 | 0.2 | short grain | 125 | beige-taupe |
| | | | | | | |
| | | | | | | |
| | | | | | | |

1.5 Photographic archival boards

89 – natural white, without an alkaline buffer



A natural white, solid colour (dyed throughout) photographic archival board without an alkaline buffer, and with a pH of 7.0. Suitable for conservation-quality picture framing and mounting, and for the presentation of photographs and other kinds of photographic material. The board is free of optical brightening agents and has passed the Photographic Activity Test (PAT) in accordance with ISO 18916.

Cuttings: Rough cuts of formats free of charge for orders > 1 packaging unit (formats can be divided into halves, thirds, quarters, sixths, eighths or ninths), other sizes on request.

| Item | Thickness (mm) | Size (cm) | Weight (gsm) | Shts./unit | Colour |
|-------|----------------|-----------|--------------|------------|---------------|
| 89054 | 0.5 | 101 x 141 | 350 | 50 | natural white |
| 89101 | 1.0 | 100 x 140 | 720 | 25 | natural white |
| 89151 | 1.5 | 100 x 140 | 1100 | 10 | natural white |
| 89201 | 2.0 | 100 x 140 | 1480 | 10 | natural white |
| | | | | | |
| | | | | | |

Shts. = sheets ; unit = packaging unit ; ¹⁾ cuttings to size, extra cost ; ²⁾ cuttings not possible ; ³⁾ without 4-sided angular cut ; ⁴⁾ units packed in poly bags ; ⁵⁾ extra cost for freight & packaging

1. Boards

1.6 Blotting boards

040 – natural white

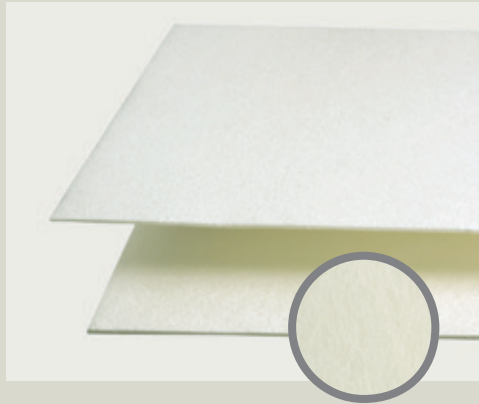

A highly absorbent, acid-free and soft-textured fleece board with good wet-strength and a high cotton fibre content, suitable for preservation and archival storage purposes. The board is pH-neutral and manufactured without the use of optical brightening agents.

Please note: Cuttings are not possible.

| Item | Thickness (mm) | Size ²⁾ (cm) | Weight (gsm) | Shts./unit | Colour |
|-------|----------------|-------------------------|--------------|------------|---------------|
| 04001 | 1.0 | 70 x 100 | 350 | 50 | natural white |
| 04004 | 1.0 | 110 x 120 | 350 | 50 | natural white |
| 04058 | 2.0 | 100 x 140 | 700 | 20 | natural white |
| | | | | | |
| | | | | | |
| | | | | | |

Shts. = sheets ; unit = packaging unit ; ¹⁾ cuttings to size, extra cost ; ²⁾ cuttings not possible ; ³⁾ without 4-sided angular cut ; ⁴⁾ units packed in poly bags ; ⁵⁾ extra cost for freight & packaging

1. Boards

1.7 Mount/mat configurator

Custom-made mounts

Based on our modular design concept you can configure your own individual mount (mat/passepartout). Our inventory allows for a variety of combination possibilities. You will find the configurator at klug-conservation.com > Products > Boards

The screenshot shows the 'Mount/mat configurator V3.0' interface on the Klug Conservation website. The page is titled 'Preserving values' and features a navigation menu with options like Home, Products, Applications, Knowledge, News, Company, Service, and Contact. The main content area is titled 'Mount/mat configurator V3.0' and includes a progress bar with steps: 1. Dimensions (active), 2. Execution, 3. Material, 4. Quantity/Title, 5. Overview, and 6. Inquiry. Below the progress bar, the user is prompted to 'Enter the dimensions of the required mat in millimetres (mm)'. A diagram shows a 400x400 mm mat with a 150x125 mm object being mounted. The mat is divided into sections with dimensions: 150 mm width for the object, 125 mm height for the object, and 125 mm margins on all sides. The total mat dimensions are 400 mm by 400 mm. The diagram also shows a 'Preview' window with a 'next >' button. The interface includes a search bar, a 'Current News' section with dates and titles, and an 'Offers' section. The footer contains the Klug Conservation logo and contact information: © 2004-2016 KLUG-CONSERVATION, Zollstraße 2, 87509 Immenstadt, Germany.



Mat configurator

2. Corrugated Boards

2.1 Corrugated boards

F 1.1 mm

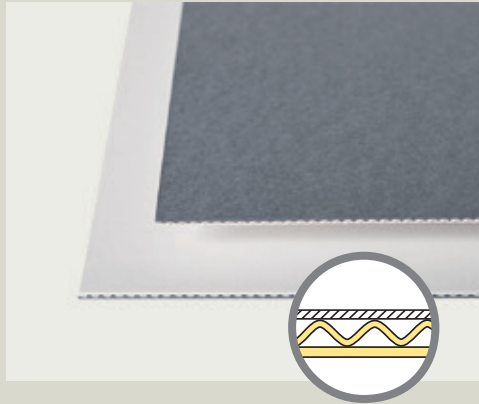

Corrugated board made from ageing-resistant material, available in overall thicknesses of 1.1 mm, natural white in colour. Top ply made from grey-blue, archival board, 190 gsm, surface specially treated, dirt-resistant, erasable and rub-proof (dry wiping). Each individual ply is glued moisture-proof. The board is ageing-resistant in accordance with the EN ISO 9706 standard. Base material used for making KLUG boxes and folders.

| Item | Thickness (mm) | Size ¹⁾ (cm) | Weight top ply (gsm) | Total weight (gsm) | Shts./unit | Colour |
|--------|----------------|-------------------------|----------------------|--------------------|------------|-------------------------|
| 011147 | 1.1 | 100 x 180 | 190 | 515 | 20 | grey-blue/natural white |
| 011247 | 1.1 | 110 x 180 | 190 | 515 | 20 | grey-blue/natural white |
| | | | | | | |
| | | | | | | |
| | | | | | | |

2.1 Corrugated boards

MW 1.6 mm

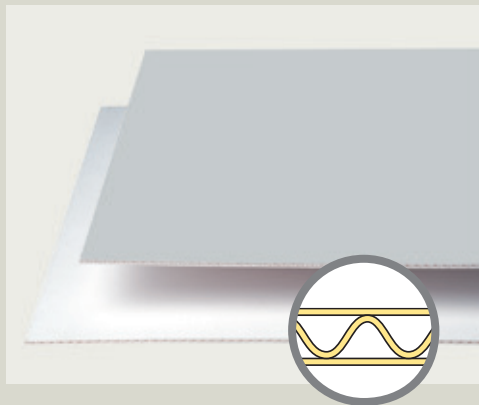

Corrugated board made from ageing-resistant material, overall thickness 1.6 mm, natural white in colour. Top ply printed light grey. Each individual ply is glued moisture-proof. The board is ageing-resistant in accordance with the EN ISO 9706 standard. Base material used for making KLUG boxes and folders and ideal as backing boards for conservation-quality picture framing.

| Item | Thickness (mm) | Size ¹⁾ (cm) | Weight top ply (gsm) | Total weight (gsm) | Shts./unit | Colour |
|--------|----------------|-------------------------|----------------------|--------------------|------------|--------------------------|
| 021104 | 1.6 | 100 x 172 | 190 | 560 | 25 | light grey/natural white |
| 021105 | 1.6 | 110 x 172 | 190 | 560 | 25 | light grey/natural white |
| | | | | | | |
| | | | | | | |
| | | | | | | |

Shts. = sheets ; unit = packaging unit ; ¹⁾ cuttings to size, extra cost ; ²⁾ cuttings not possible ; ³⁾ without 4-sided angular cut ; ⁴⁾ units packed in poly bags ; ⁵⁾ extra cost for freight & packaging

2. Corrugated Boards

2.1 Corrugated boards

MW 1.65 mm

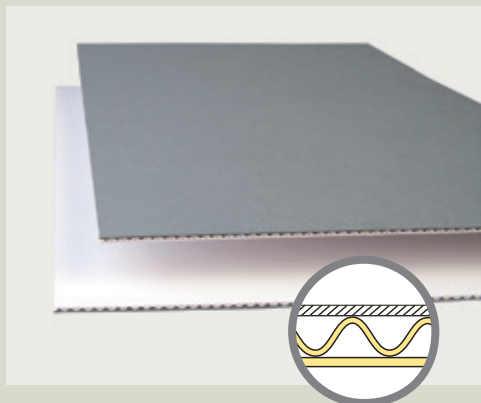

Corrugated board made from ageing-resistant material, overall thickness 1.65 mm, natural white in colour. Top ply made from grey-blue archival board, 190 gsm, surface specially treated, dirt-resistant, erasable and rub-proof (dry wiping). Each individual ply is glued moisture-proof. The board is ageing-resistant in accordance with the EN ISO 9706 standard. Base material used for making KLUG boxes and folders and ideal as backing boards for conservation-quality picture framing.

| Item | Thickness (mm) | Size ¹⁾ (cm) | Weight top ply (gsm) | Total weight (gsm) | Shts./unit | Colour |
|----------|----------------|-------------------------|----------------------|--------------------|------------|-------------------------|
| 02110447 | 1.65 | 100 x 172 | 190 | 560 | 25 | grey-blue/natural white |
| 02110547 | 1.65 | 110 x 172 | 190 | 560 | 25 | grey-blue/natural white |
| | | | | | | |
| | | | | | | |
| | | | | | | |

2.1 Corrugated boards

MW 1.7 mm

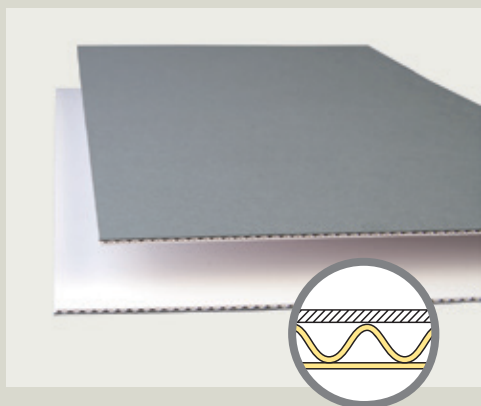

Corrugated board made from ageing-resistant material, overall thickness 1.7 mm, natural white in colour. Top ply made from grey-blue archival board, 300 gsm, surface specially treated, dirt-resistant, erasable and rub-proof (dry wiping). Each individual ply is glued moisture-proof. The board is ageing-resistant in accordance with the EN ISO 9706 standard. Base material used for making KLUG boxes and folders and ideal as backing boards for conservation-quality picture framing.

| Item | Thickness (mm) | Size ¹⁾ (cm) | Weight top ply (gsm) | Total weight (gsm) | Shts./unit | Colour |
|--------|----------------|-------------------------|----------------------|--------------------|------------|-------------------------|
| 021147 | 1.7 | 100 x 172 | 300 | 680 | 20 | grey-blue/natural white |
| 021247 | 1.7 | 110 x 172 | 300 | 680 | 20 | grey-blue/natural white |
| 021109 | 1.7 | 180 x 245 ⁵⁾ | 300 | 680 | 10 | grey-blue/natural white |
| | | | | | | |
| | | | | | | |

Shts. = sheets ; unit = packaging unit ; ¹⁾ cuttings to size, extra cost ; ²⁾ cuttings not possible ; ³⁾ without 4-sided angular cut ; ⁴⁾ units packed in poly bags ; ⁵⁾ extra cost for freight & packaging

2. Corrugated Boards

2.1 Corrugated boards

MW 1.8 mm

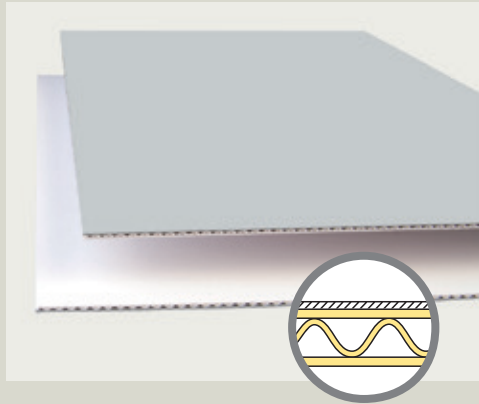

Corrugated board made from ageing-resistant material, overall thickness 1.8 mm, natural white in colour. Top ply laminated with light grey archival paper (048), 130 gsm, surface specially treated, dirt-resistant, erasable and rub-proof (dry wiping). The board is ageing-resistant in accordance with the EN ISO 9706 standard. Base material used for making KLUG boxes and folders and ideal as backing boards for conservation-quality picture framing.

| Item | Thickness (mm) | Size ¹⁾ (cm) | Weight top ply (gsm) | Total weight (gsm) | Shts./unit | Colour |
|--------|----------------|-------------------------|----------------------|--------------------|------------|--------------------------|
| 021148 | 1.8 | 100 x 172 | 130 | 730 | 20 | light grey/natural white |
| | | | | | | |
| | | | | | | |
| | | | | | | |
| | | | | | | |

2.1 Corrugated boards

FW 3.0 mm

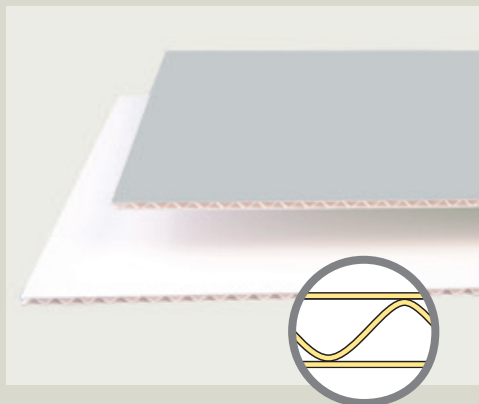

Corrugated board made from ageing-resistant material, natural white in colour. Overall thickness 3.0 mm. Top ply printed light grey. Each individual ply is glued moisture-proof (wet-strengthened). The board is ageing-resistant in accordance with the EN ISO 9706 standard. Base material used for making KLUG boxes and folders and ideal as backing boards for conservation-quality picture framing.

| Item | Thickness (mm) | Size ¹⁾ (cm) | Weight top ply (gsm) | Total weight (gsm) | Shts./unit | Colour |
|--------|----------------|-------------------------|----------------------|--------------------|------------|--------------------------|
| 031104 | 3.0 | 100 x 172 | 190 | 570 | 20 | light grey/natural white |
| 031105 | 3.0 | 110 x 172 | 190 | 570 | 20 | light grey/natural white |
| 031106 | 3.0 | 215 x 165 ⁵⁾ | 190 | 570 | 15 | light grey/natural white |
| 031107 | 3.0 | 180 x 245 ⁵⁾ | 190 | 570 | 10 | light grey/natural white |
| | | | | | | |
| | | | | | | |

Shts. = sheets ; unit = packaging unit ; ¹⁾ cuttings to size, extra cost ; ²⁾ cuttings not possible ; ³⁾ without 4-sided angular cut ; ⁴⁾ units packed in poly bags ; ⁵⁾ extra cost for freight & packaging

2. Corrugated Boards

2.1 Corrugated boards

FW 3.1 mm

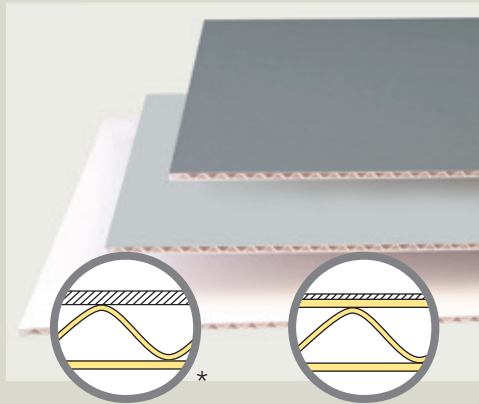

Corrugated board made from ageing-resistant material, natural white in colour. Overall thickness 3.1 mm. Top ply made from grey-blue archival board 300 gsm or laminated with light grey (048) archival paper, 130 gsm. Surface specially treated, dirt-resistant, erasable and rub-proof (dry wiping). Each individual ply is glued moisture-proof (wet-strengthened). The board is ageing-resistant in accordance with the EN ISO 9706 standard. Base material used for making KLUG boxes and folders and ideal as backing boards for conservation-quality picture framing.

| Item | Thickness (mm) | Size ¹⁾ (cm) | Weight top ply (gsm) | Total weight (gsm) | Shts./unit | Colour |
|------------|----------------|-------------------------|----------------------|--------------------|------------|--------------------------|
| 031147 * | 3.1 | 100 x 172 | 300 | 680 | 20 | grey-blue/natural white |
| 03147107 * | 3.1 | 180 x 245 ⁵⁾ | 300 | 680 | 5 | grey-blue/natural white |
| 031148 | 3.1 | 100 x 172 | 130 | 740 | 20 | light grey/natural white |
| | | | | | | |
| | | | | | | |
| | | | | | | |

2.1 Corrugated boards

EF 2.7 mm

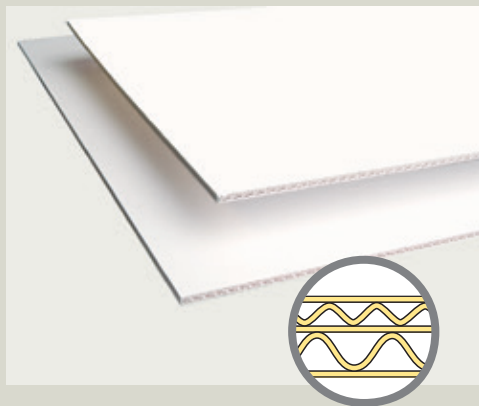

Double corrugated board made of ageing-resistant material, overall thickness 2.7 mm, natural white in colour. Flute thicknesses 1.6 and 1.1 mm. The board is ageing resistant in accordance with the EN ISO 9706 standard, breathable, possesses very good planarity (flatness), easy processing characteristics. Base material used for making KLUG boxes and folders, very suitable as backing boards for conservation-quality picture framing.

| Item | Thickness (mm) | Size ¹⁾ (cm) | Weight top ply (gsm) | Total weight (gsm) | Shts./unit | Colour |
|---------|----------------|-------------------------|----------------------|--------------------|------------|-----------------------------|
| 0211103 | 2.7 | 90 x 120 | 190 | 900 | 10 | natural white/natural white |
| | | | | | | |
| | | | | | | |
| | | | | | | |

Shts. = sheets ; unit = packaging unit ; ¹⁾ cuttings to size, extra cost ; ²⁾ cuttings not possible ; ³⁾ without 4-sided angular cut ; ⁴⁾ units packed in poly bags ; ⁵⁾ extra cost for freight & packaging

2. Corrugated Boards

2.1 Corrugated boards

EF 3.0 mm



Double corrugated board made of ageing-resistant material, overall thickness 3.0 mm, natural white in colour. Flute thicknesses 1.6 and 1.1 mm. Top ply made from conservation board, natural white, weight 365 gsm. The board is ageing-resistant in accordance with the EN ISO 9706 standard, has very good flatness and easy processing characteristics, and is breathable. Ideal as backing boards for conservation-quality picture framing.

| Item | Thickness (mm) | Size ¹⁾ (cm) | Weight top ply (gsm) | Total weight (gsm) | Shts./unit | Colour |
|----------|----------------|-------------------------|----------------------|--------------------|-----------------|------------------------|
| 0211117 | 3.0 | 90 x 120 | 365 | 1100 | 10 | natural white/offwhite |
| 02111178 | 3.0 | 100 x 140 | 365 | 1100 | 10 | natural white/offwhite |
| 02111170 | 3.0 | 180 x 220 ⁵⁾ | 365 | 1100 | 3 ⁴⁾ | natural white/offwhite |
| | | | | | | |
| | | | | | | |
| | | | | | | |

2.1 Corrugated boards

EB 4.5 mm

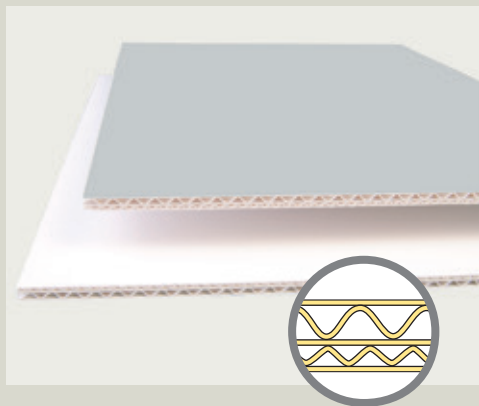

Double wall corrugated board made from ageing-resistant material, overall thickness 4.5 mm, natural white in colour. Flute thicknesses 3.0 and 1.5 mm. Top ply printed light grey. The board has very good flatness and easy processing characteristics, is breathable and ageing resistant in accordance with the EN ISO 9706 standard. Very suitable as backing boards for conservation-quality picture framing.

| Item | Thickness (mm) | Size ¹⁾ (cm) | Weight top ply (gsm) | Total weight (gsm) | Shts./unit | Colour |
|----------|----------------|-------------------------|----------------------|--------------------|------------|--------------------------|
| 021-031 | 4.5 | 100 x 172 | 190 | 940 | 10 | light grey/natural white |
| 021-0315 | 4.5 | 110 x 172 | 190 | 940 | 10 | light grey/natural white |
| | | | | | | |
| | | | | | | |
| | | | | | | |

Shts. = sheets ; unit = packaging unit ; ¹⁾ cuttings to size, extra cost ; ²⁾ cuttings not possible ; ³⁾ without 4-sided angular cut ; ⁴⁾ units packed in poly bags ; ⁵⁾ extra cost for freight & packaging

2. Corrugated Boards

2.1 Corrugated boards

EB 5.0 mm

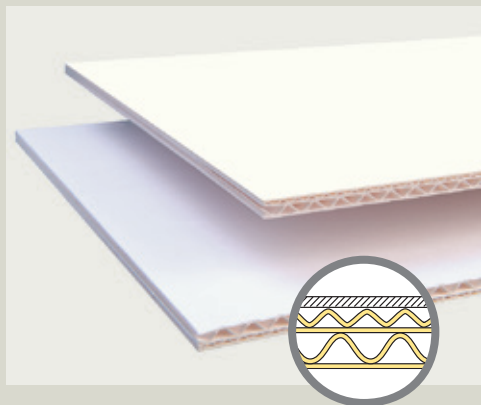

Double wall corrugated board made from ageing-resistant material, overall thickness 5.0 mm, natural white in colour. Flute thicknesses 3.0 and 1.5 mm. Top ply made from 365 gsm conservation board, natural white. The board has very good flatness and easy processing characteristics, is breathable and ageing-resistant in accordance with the EN ISO 9706 standard. Very suitable as backing boards for conservation-quality picture framing.

| Item | Thickness (mm) | Size ¹⁾ (cm) | Weight top ply (gsm) | Total weight (gsm) | Shts./unit | Colour |
|----------|----------------|-------------------------|----------------------|--------------------|------------|------------------------|
| 02131176 | 5.0 | 180 x 120 | 365 | 1160 | 10 | natural white/offwhite |
| | | | | | | |
| | | | | | | |
| | | | | | | |
| | | | | | | |

2.1 Corrugated boards

BC 6.4 mm

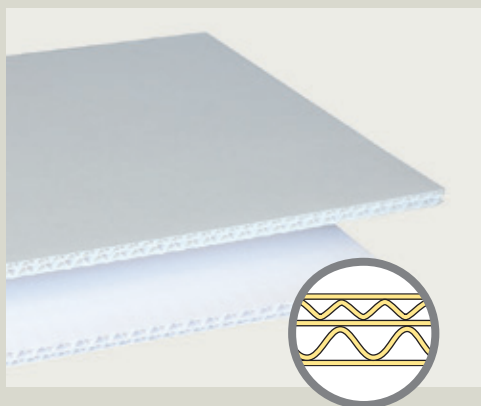

Double wall corrugated board made from ageing-resistant material, overall thickness 6.4 mm, natural white in colour. Flute thicknesses 3.0 and 3.4 mm. Top ply printed light grey. Each individual ply is glued moisture-proof. The board is ageing-resistant in accordance with the EN ISO 9706 standard. Base material used for making KLUG boxes and folders, very suitable as backing boards for conservation-quality picture framing.

| Item | Thickness (mm) | Size ¹⁾ (cm) | Weight top ply (gsm) | Total weight (gsm) | Shts./unit | Colour |
|---------|----------------|-------------------------|----------------------|--------------------|------------|--------------------------|
| 0314107 | 6.4 | 182 x 252 ⁵⁾ | 190 | 960 | 5 | light grey/natural white |
| | | | | | | |
| | | | | | | |
| | | | | | | |
| | | | | | | |

Shts. = sheets ; unit = packaging unit ; ¹⁾ cuttings to size, extra cost ; ²⁾ cuttings not possible ; ³⁾ without 4-sided angular cut ; ⁴⁾ units packed in poly bags ; ⁵⁾ extra cost for freight & packaging

2. Corrugated Boards

2.1 Corrugated boards

EBB 8.0 mm

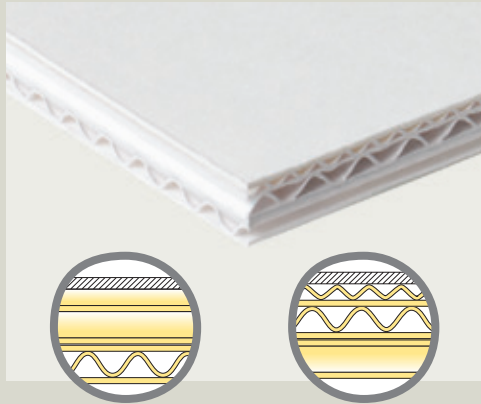

Triple wall corrugated board made from ageing-resistant material, overall thickness 8.0 mm, natural white in colour. Flutes in crosswise direction (cross-laminated) with thicknesses 3.0, 1.5 and 3.0 mm. Top ply made from conservation board, weight 365 gsm, natural white in colour. The board is ageing-resistant in accordance with the EN ISO 9706 standard, with excellent flatness and is breathable. Suitable as backing boards for conservation-quality picture framing.

| Item | Thickness (mm) | Size ¹⁾ (cm) | Weight top ply (gsm) | Total weight (gsm) | Shts./unit | Colour |
|------------|----------------|-------------------------|----------------------|--------------------|------------|------------------------|
| 0213131176 | 8.0 | 120 x 180 | 365 | 1735 | 5 | natural white/offwhite |
| | | | | | | |
| | | | | | | |
| | | | | | | |
| | | | | | | |
| | | | | | | |

Shts. = sheets ; unit = packaging unit ; ¹⁾ cuttings to size, extra cost ; ²⁾ cuttings not possible ; ³⁾ without 4-sided angular cut ; ⁴⁾ units packed in poly bags ; ⁵⁾ extra cost for freight & packaging

3. Honeycomb Panels

3.1 Honeycomb panels

071 – natural white



Honeycomb panels made of ageing-resistant material in accordance with the EN ISO 9706. Very suitable as backing boards to support large works of art such as graphics, placards, textiles, paintings and wallpapers. The panels are manufactured without the use of optical brightening agents and have passed the Photographic Activity Test (PAT) in accordance with ISO 18916.

| Item | Thickness (mm) | Size ¹⁾ (cm) | Weight (gsm) | Shts./unit | Colour |
|---------|----------------|-------------------------|--------------|------------|---------------|
| 0711083 | 8.3 | 140 x 200 ⁵⁾ | 1100 | 5 | natural white |
| 071314 | 13.0 | 125 x 140 ⁵⁾ | 1350 | 10 | natural white |
| 0711134 | 13.0 | 140 x 250 ⁵⁾ | 1350 | 5 | natural white |
| | | | | | |
| | | | | | |
| | | | | | |

Shts. = sheets ; unit = packaging unit ; ¹⁾ cuttings to size, extra cost ; ²⁾ cuttings not possible ; ³⁾ without 4-sided angular cut ; ⁴⁾ units packed in poly bags ; ⁵⁾ extra cost for freight & packaging

4. Paper

4.1 Archival paper

047 – grey-blue / 048 – light grey



Ageing resistant, solid coloured archival paper sheets – suitable for the usage as interleaving sheets in files and folders. Due to special surface treatment dirt-resistant, erasable and rub-proof (dry wiping). The paper possesses excellent light-fastness.

Cuttings: Rough cuts of formats free of charge for orders > 1 packaging unit (formats can be divided into halves, thirds, quarters, sixths, eighths or ninths), other sizes on request.

| Item | Weight (gsm) | Size (cm) | Thickness (mm) | Grain | Shts./unit | Colour |
|---------|--------------|-----------|----------------|------------|------------|------------|
| 047/130 | 130 | 101 x 173 | 0.15 | long grain | 100 | grey-blue |
| 048/130 | 130 | 101 x 173 | 0.15 | long grain | 100 | light grey |
| | | | | | | |
| | | | | | | |
| | | | | | | |
| | | | | | | |

4.1 Archival paper

047 – grey-blue archival paper on reels



Ageing-resistant, solid grey-blue archival paper rolled on reels – suitable for the usage as interleaving sheets in files and folders. Due to special surface treatment dirt-resistant, erasable and rub-proof (dry wiping). The paper possesses excellent light-fastness.

Delivery: Packed in a box made of corrugated board, weight/reel approximately 24 kg.

| Item | Weight (gsm) | Thickness (mm) | Reel width ²⁾ (cm) | Running metres (m) | Reel/unit | Colour |
|-------|--------------|----------------|-------------------------------|--------------------|-----------|-----------|
| 04713 | 130 | 0.15 | 120 | 150 | 1 | grey-blue |
| | | | | | | |
| | | | | | | |
| | | | | | | |
| | | | | | | |

Shts. = sheets ; unit = packaging unit ; ¹⁾ cuttings to size, extra cost ; ²⁾ cuttings not possible ; ³⁾ without 4-sided angular cut ; ⁴⁾ units packed in poly bags ; ⁵⁾ extra cost for freight & packaging

4. Paper

4.2 Photographic archival paper

natural white – without an alkaline buffer



Natural white coloured photographic archival paper without an alkaline buffer and with a pH of 7.0. The paper is acid-free, manufactured without optical brightening agents and is suitable for the archival storage of photographs, aquarell paintings, graphics and textiles. The paper has passed the Photographic Activity Test (PAT) in accordance with ISO 18916.

Cuttings: Rough cuts of formats free of charge for orders > 1 packaging unit (formats can be divided into halves, thirds, quarters, sixths, eighths or ninths), other sizes on request.

| Item | Weight (gsm) | Size (cm) | Thickness (mm) | Shts./unit | Colour |
|----------|--------------|------------------------|----------------|------------|---------------|
| 8102445 | 45 | 121 x 91 ²⁾ | 0.05 | 250 | natural white |
| 81024090 | 90 | 101 x 141 | 0.11 | 100 | natural white |
| 81024 | 120 | 100 x 140 | 0.15 | 100 | natural white |
| 8104 | 120 | 21.0 x 29.7 (A4) | 0.15 | 500 | natural white |
| | | | | | |
| | | | | | |

4. Paper

4.3 Museum Paper

light white – with an alkaline buffer



Ageing resistant, white coloured museum and photographic archival paper with an alkaline buffer, suitable as photocopy paper, for wrapping, separating and as interleaving sheets in folders, spans, files and binders. The paper has passed the Photographic Activity Test (PAT) in accordance with the ISO 18916 norm.

Cuttings: Rough cuts of formats free of charge for orders > 1 packaging unit (formats can be divided into halves, thirds, quarters, sixths, eighths or ninths), other sizes on request.

| Item | Weight (gsm) | Size (cm) | Thickness (mm) | Shts./unit | Colour |
|--|--------------|-----------------------|----------------|------------|-------------|
| <i>Museum and photographic archival paper 101 x 141 cm</i> | | | | | |
| 015090 | 90 | 101 x 141 long grain | 0.11 | 100 | light white |
| 015120 | 120 | 101 x 141 long grain | 0.15 | 50 | light white |
| 015160 | 160 | 101 x 141 long grain | 0.20 | 50 | light white |
| 015200 | 200 | 101 x 141 short grain | 0.23 | 50 | light white |
| 015250 | 250 | 101 x 141 short grain | 0.28 | 25 | light white |
| 015300 | 300 | 101 x 141 short grain | 0.32 | 25 | light white |
| <i>Museum and photographic archival paper A4 size</i> | | | | | |
| 0150904 | 90 | 21.0 x 29.7 (A4) | 0.11 | 500 | light white |
| 0151204 | 120 | 21.0 x 29.7 (A4) | 0.15 | 500 | light white |
| 0151604 | 160 | 21.0 x 29.7 (A4) | 0.20 | 500 | light white |
| 0152004 | 200 | 21.0 x 29.7 (A4) | 0.23 | 500 | light white |
| 0152504 | 250 | 21.0 x 29.7 (A4) | 0.28 | 500 | light white |
| | | | | | |
| | | | | | |
| | | | | | |
| | | | | | |
| | | | | | |
| | | | | | |
| | | | | | |
| | | | | | |
| | | | | | |
| | | | | | |

Shts. = sheets ; unit = packaging unit ; ¹⁾ cuttings to size, extra cost ; ²⁾ cuttings not possible ; ³⁾ without 4-sided angular cut ; ⁴⁾ units packed in poly bags ; ⁵⁾ extra cost for freight & packaging

4. Paper

4.3 Museum paper

coloured – with an alkaline buffer

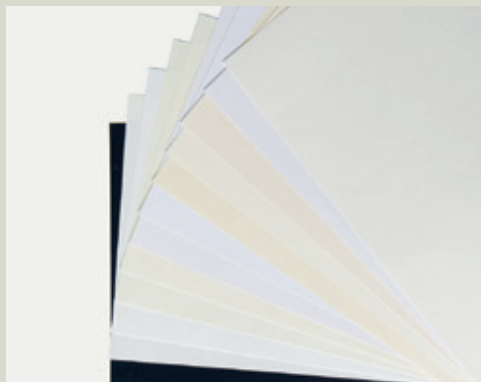

Coloured, ageing-resistant museum paper with an alkaline reserve offering maximum permanency. Suitable as photocopy paper and as interleaving sheets in folders, spans, files and binders.

Cuttings: Rough cuts of formats free of charge for orders > 1 packaging unit (formats can be divided into halves, thirds, quarters, sixths, eighths or ninths), other sizes on request.

Please note: The illustrated surface colours and structures approximately match the actual products. For exact colour and surface structure please request for a sample.

| Item | Weight (gsm) | Size (cm) | Thickness (mm) | Shts./unit | Colour |
|--------------------------------|--------------|------------|----------------|------------|-------------------------|
| <i>H10 – H25, white shades</i> | | | | | |
| 12101 | 130 | 81 x 101 | 0.15 | 100 | H10 porcelain, ribbed |
| 12102 | 130 | 101 x 141 | 0.15 | 100 | H10 porcelain, ribbed |
| 12111 | 130 | 81 x 101 | 0.15 | 100 | H11 pure white, ribbed |
| 12112 | 130 | 101 x 141 | 0.15 | 100 | H11 pure white, ribbed |
| 12121 | 130 | 81 x 101 | 0.15 | 100 | H12 powder, ribbed |
| 12122 | 130 | 101 x 141 | 0.15 | 100 | H12 powder, ribbed |
| 12131 | 130 | 81 x 101 | 0.15 | 100 | H13 chamois, vellum |
| 12132 | 130 | 101 x 141 | 0.15 | 100 | H13 chamois, vellum |
| 12141 | 130 | 81 x 101 | 0.15 | 100 | H14 ivory, vellum |
| 12142 | 130 | 101 x 141 | 0.15 | 100 | H14 ivory, vellum |
| 12201 | 130 | 81 x 101 | 0.15 | 100 | H20 snow white, vellum |
| 12202 | 130 | 101 x 141 | 0.15 | 100 | H20 snow white, vellum |
| 122101 | 130 | 104.5 x 86 | 0.15 | 100 | H21 lucid white, ribbed |
| 122102 | 130 | 101 x 141 | 0.15 | 100 | H21 lucid white, ribbed |
| 12221 | 130 | 104.5 x 86 | 0.15 | 100 | H22 white, vellum |
| 12251 | 130 | 104.5 x 86 | 0.15 | 100 | H25 white, ribbed |
| <i>H68, black</i> | | | | | |
| 12681 | 130 | 107 x 86 | 0.15 | 50 | H68 black, ribbed |
| | | | | | |
| | | | | | |
| | | | | | |
| | | | | | |
| | | | | | |
| | | | | | |
| | | | | | |
| | | | | | |
| | | | | | |
| | | | | | |
| | | | | | |
| | | | | | |
| | | | | | |
| | | | | | |
| | | | | | |

Shts. = sheets ; unit = packaging unit ; ¹⁾ cuttings to size, extra cost ; ²⁾ cuttings not possible ; ³⁾ without 4-sided angular cut ; ⁴⁾ units packed in poly bags ; ⁵⁾ extra cost for freight & packaging

4. Paper

4.4 Japanese paper

Japanese paper – sheets



Japanese paper sheets without an alkaline buffer, weight 9.0 gsm, machine glazed single-sided. Suitable as interleaving sheets for archiving, conservation and preservation purposes – for example to laminate objects, repair cracks and fissures and also to mount objects such as graphics and photographs etc. Manufactured from long-fibred cellulose (Abaca/Manila hemp, bleached/totally chlorine-free) and without the use of optical brightening agents.

| Item | Weight (gsm) | Size ²⁾ (cm) | pH value | Shts./unit ⁴⁾ | Colour |
|-----------|--------------|-------------------------|----------|--------------------------|--------|
| 0100954 | 9.0 | 51 x 76 | 7.0 | 100 | white |
| 010096191 | 9.0 | 61 x 91 | 7.0 | 500 | white |
| | | | | | |
| | | | | | |
| | | | | | |

4.4 Japanese paper

Japanese paper – on reels

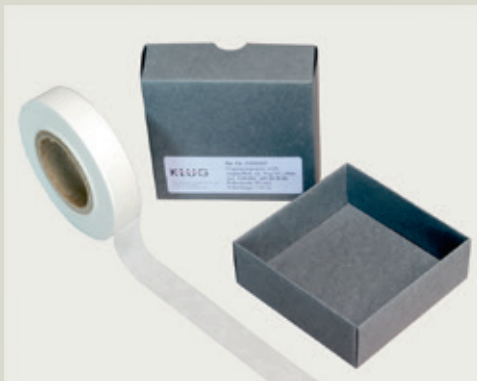

Japanese paper without an alkaline buffer, rolled on small reels, weight 9.0 gsm, width 2 or 3 cm, reel length 150 m. Suitable as interleaving sheets for archiving, conservation and preservation purposes – for example to laminate objects, to repair cracks and fissures and also to mount objects such as graphics and photographs etc. Manufactured from long-fibred cellulose (Abaca/Manila hemp, bleached/totally chlorine-free) and without the use of optical brightening agents.

| Item | Weight (gsm) | Reel width ²⁾ (cm) | Running metres (m) | pH value | Reel/unit ⁴⁾ | Colour |
|--------|--------------|-------------------------------|--------------------|----------|-------------------------|--------|
| 010097 | 9.0 | 2 | 150 | 7.0 | 1 | white |
| 010098 | 9.0 | 3 | 150 | 7.0 | 1 | white |
| | | | | | | |
| | | | | | | |
| | | | | | | |

Shts. = sheets ; unit = packaging unit ; ¹⁾ cuttings to size, extra cost ; ²⁾ cuttings not possible ; ³⁾ without 4-sided angular cut ; ⁴⁾ units packed in poly bags ; ⁵⁾ extra cost for freight & packaging

4. Paper

4.5 Silk tissue paper

Silk tissue paper sheets – w/o alkaline buffer



Silk tissue paper without an alkaline buffer, machine glazed single-sided, pH 7.0, acid-free and manufactured without the usage of optical brightening agents. Suitable as as wrapping paper for the archival storage of photographs, aquarelle paintings. The tissue paper has passed the Photographic Activity Test (PAT) in accordance with ISO 18916.

| Item | Weight (gsm) | Size ²⁾ (cm) | pH value | Shts./unit ⁴⁾ | Colour |
|---------|--------------|-------------------------|----------|--------------------------|--------|
| 0101-52 | 17 – 18 | 75 x 50 | 7.0 | 1000 | white |
| 01014 | 17 – 18 | 75 x 100 | 7.0 | 250 | white |
| 0101 | 17 – 18 | 75 x 100 | 7.0 | 500 | white |
| | | | | | |
| | | | | | |

4.5 Silk tissue paper

Silk tissue paper on reels – w/o alkaline buffer



Silk tissue paper without an alkaline buffer, rolled on reels, machine glazed single-sided, pH 7.0, acid-free and manufactured without the usage of optical brightening agents. Suitable as wrapping paper for the archival storage of photographs, paintings, graphics and textiles and as padding material for delicate objects. The tissue paper has passed the Photographic Activity Test (PAT) in accordance with ISO 18916.

| Item | Weight (gsm) | Reel width ²⁾ (cm) | Running metres (m) | pH value | Reel/unit ⁴⁾ | Colour |
|--------|--------------|-------------------------------|--------------------|----------|-------------------------|--------|
| 010182 | 18 | 130 | 500 | 7.0 | 1 | white |
| | | | | | | |
| | | | | | | |

Shts. = sheets ; unit = packaging unit ; ¹⁾ cuttings to size, extra cost ; ²⁾ cuttings not possible ; ³⁾ without 4-sided angular cut ; ⁴⁾ units packed in poly bags ; ⁵⁾ extra cost for freight & packaging

4. Paper

4.5 Silk tissue paper

Silk tissue paper sheets – with an alkaline buffer



White coloured silk tissue paper, buffered with natural calcium carbonate (GCC), pH between 8.0 – 9.5, acid-free and manufactured without the usage of optical brightening agents. Suitable as wrapping paper for archival storage of photographs, aquarelle paintings, graphics and textiles. The tissue paper has passed the Photographic Activity Test (PAT) in accordance with ISO 18916.

| Item | Weight (gsm) | Size ²⁾ (cm) | pH value | Shts./unit ⁴⁾ | Colour |
|-------|--------------|-------------------------|-----------|--------------------------|--------|
| 01034 | 28 | 76 x 100 | 8.0 – 9.5 | 250 | white |
| 0103 | 28 | 76 x 100 | 8.0 – 9.5 | 500 | white |
| | | | | | |
| | | | | | |
| | | | | | |

4.5 Silk tissue paper

Silk tissue paper on reels – with an alkaline buffer



White silk tissue paper rolled on reels, buffered with natural calcium carbonate (GCC), pH between 8.0 – 9.5, acid-free and manufactured without the usage of optical brightening agents. Suitable as wrapping paper for archiving photographs, aquarelle paintings, graphics, textiles and as padding material for delicate objects. The tissue paper has passed the Photographic Activity Test (PAT) in accordance with ISO 18916.

| Item | Weight (gsm) | Reel width ²⁾ (cm) | Running metres (m) | pH value | Reel/unit ⁴⁾ | Colour |
|-------|--------------|-------------------------------|--------------------|-----------|-------------------------|--------|
| 01031 | 21 | 100 | 500 | 8.0 – 9.5 | 1 | white |
| | | | | | | |
| | | | | | | |
| | | | | | | |

Shts. = sheets ; unit = packaging unit ; ¹⁾ cuttings to size, extra cost ; ²⁾ cuttings not possible ; ³⁾ without 4-sided angular cut ; ⁴⁾ units packed in poly bags ; ⁵⁾ extra cost for freight & packaging

4. Paper

4.6 Glassine paper

Glassine paper transparent – sheets



Transparent glassine paper without an alkaline buffer, pH between 6.9 – 7.2, acid-free, manufactured without the usage of optical brightening agents. Suitable for the archival storage of photographs and negatives. The glassine paper has passed the Photographic Activity Test (PAT) in accordance with ISO 18916.

| Item | Weight (gsm) | Size ²⁾ (cm) | pH value | Shts./unit ⁴⁾ | Colour |
|-------|--------------|-------------------------|-----------|--------------------------|--------|
| 0102 | 30 | 70 x 100 | 6.9 – 7.2 | 500 | white |
| 01024 | 30 | 70 x 100 | 6.9 – 7.2 | 250 | white |
| | | | | | |
| | | | | | |
| | | | | | |

4.6 Glassine paper

Glassine paper transparent – on reels



Transparent glassine paper rolled on reels, without an alkaline buffer, pH between 6.9 – 7.2, acid-free, manufactured without the usage of optical brightening agents. Suitable for the archival storage of photographs and negatives. The glassine paper has passed the Photographic Activity Test (PAT) in accordance with ISO 18916.

| Item | Weight (gsm) | Reel width ²⁾ (cm) | Running metres (m) | pH value | Reel/unit ⁴⁾ | Colour |
|-------|--------------|-------------------------------|--------------------|-----------|-------------------------|-------------|
| 01022 | 30 | 120 | 500 | 6.9 – 7.2 | 1 | transparent |
| 01025 | 90 | 157 | 50 | 6.9 – 7.2 | 1 | transparent |
| | | | | | | |
| | | | | | | |
| | | | | | | |

Shts. = sheets ; unit = packaging unit ; ¹⁾ cuttings to size, extra cost ; ²⁾ cuttings not possible ; ³⁾ without 4-sided angular cut ; ⁴⁾ units packed in poly bags ; ⁵⁾ extra cost for freight & packaging

4. Paper

4.7 Novo test paper

wood-free



Test paper for paper deacidification, recommended by the "German Institute for Standardization DIN – for the examination of successful deacidification treatment procedures of acidic based printing and writing papers".

Surface structure calendered, manufactured without the usage of optical brightening agents.

| Item | Weight (gsm) | Size (cm) | Material | Shts./unit ⁴⁾ | Colour |
|--------|--------------|-----------|-------------------------------|--------------------------|--------|
| 007091 | 70 | 70 x 100 | wood-free, surface calendered | 250 | white |
| | | | | | |
| | | | | | |
| | | | | | |
| | | | | | |
| | | | | | |

Shts. = sheets ; unit = packaging unit ; ¹⁾ cuttings to size, extra cost ; ²⁾ cuttings not possible ; ³⁾ without 4-sided angular cut ; ⁴⁾ units packed in poly bags ; ⁵⁾ extra cost for freight & packaging

5. Folders

5.1 File folders/drawing portfolios

without flaps

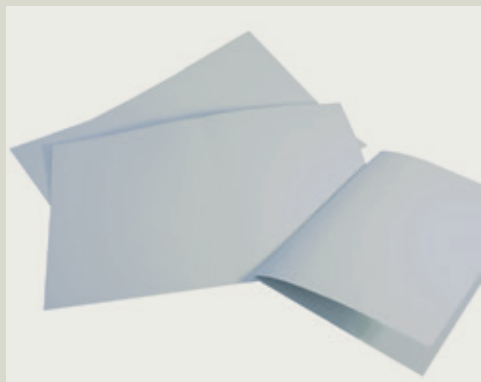

File folders and drawing portfolios without flaps and with centred grooves. Delivery flat and unfolded.

This is a very reasonable and inexpensive archiving system. Upon request we can also deliver A4 size folders with pre-punched holes for ring-binding or with attached textile ribbons.

| Item | For size design | Dimensions closed H x W (mm) | Dimensions open H x W (mm) | Material, weight (gsm), colour |
|--|-----------------|------------------------------|----------------------------|---------------------------------|
| <i>For A4 size</i> | | | | |
| 04865 | A4 | 318 x 230/230 | 318 x 460 | archival board, 240, light grey |
| 048651 | A4 | 318 x 230/230 | 318 x 460 | archival board, 330, light grey |
| <i>For folio and large folio sizes</i> | | | | |
| 04864 | folio | 345 x 230/230 | 345 x 460 | archival board, 240, light grey |
| 048641 | folio | 345 x 230/230 | 345 x 460 | archival board, 330, light grey |
| 04866 | large folio | 395 x 250/250 | 395 x 500 | archival board, 240, light grey |
| 048661 | large folio | 395 x 250/250 | 395 x 500 | archival board, 330, light grey |
| <i>For A3 size</i> | | | | |
| 04863 | A3 | 425 x 320/320 | 425 x 640 | archival board, 240, light grey |
| 048631 | A3 | 425 x 320/320 | 425 x 640 | archival board, 330, light grey |
| <i>For A2 size</i> | | | | |
| 0486001 | A2 | 600 x 440/440 | 600 x 880 | archival board, 240, light grey |
| 0486011 | A2 | 600 x 440/440 | 600 x 880 | archival board, 330, light grey |
| <i>For A1 size</i> | | | | |
| 048731 | A1 | 850 x 605/605 | 850 x 1210 | archival board, 240, light grey |
| 048733 | A1 | 850 x 605/605 | 850 x 1210 | archival board, 330, light grey |
| <i>For A0 size</i> | | | | |
| 048752 | A0 | 1200 x 850/850 | 1200 x 1700 | archival board, 400, light grey |
| | | | | |
| | | | | |
| | | | | |
| | | | | |
| | | | | |
| | | | | |
| | | | | |
| | | | | |

Unit = packaging unit ; H = height ; W = width ; T = thickness ; D = depth ; L = length

5. Folders

5.2 Preservation folders



Stackable preservation folders available with or without flaps for embedding valuable and pressure-sensitive archival objects of various sizes. The object is embedded in a bed frame made of either conservation board, corrugated board or a honeycomb panel. The bed frame is glued to a folder. The embeded object is provided a safe housing from all kinds of mechanical impacts.

| Item | For size design | Int. dimensions L x W x H (mm) | Ext. dimensions L x W x H (mm) | Material, weight (gsm), colour |
|--------|--|-----------------------------------|-----------------------------------|--------------------------------|
| 0489xx | individual sizes and designs available | | | |
| | | | | |
| | | | | |
| | | | | |
| | | | | |
| | | | | |

5.3 Folders with filing mechanism



An archival folder "Brauweiler Folder" with a filing mechanism for filing sheets of A4, folio and large folio sizes. Made from archival board 048, 330 gsm, light grey in colour. Due to special surface treatment dirt-resistant, erasable and rub-proof (dry wiping). The folder also includes a polyimide filing mechanism. Other sizes on request.

| Item | For size design | Int. dimensions L x W x H (mm) | Ext. dimensions L x W x H (mm) | Material, weight (gsm), colour |
|--------|-----------------|-----------------------------------|-----------------------------------|---------------------------------|
| 940150 | A4 | 310 x 225 x 70 | 311 x 226 x 71 | archival board, 330, light grey |
| 940154 | folio | 336 x 225 x 70 | 337 x 256 x 71 | archival board, 330, light grey |
| 940156 | large folio | 355 x 255 x 70 | 356 x 256 x 71 | archival board, 330, light grey |
| | | | | |
| | | | | |
| | | | | |

Unit = packaging unit ; H = height ; W = width ; T = thickness ; D = depth ; L = length

5. Folders

5.4 Expansion folders

Juris folders (standard assortment ex-stock)



Expansion folders, also called "Juris Folders", are made from a single sheet, with multiple grooves on the flaps. Customer imprints possible. The folders can be delivered with loose or pre-stuck base reinforcements. This prevents the originals being archived against external damages that can get caused due to bending. This minimal enhancement increases the value-for-money aspect to a great degree.

A large range of standard sizes available ex-stock.

| Item | For size (cm) design | Int. dimensions H x W x T (mm) | Material, weight (gsm), colour |
|--|----------------------|--------------------------------|---------------------------------|
| <i>Juris folder for size A5</i> | | | |
| 04820501 | A5 | 220 x 170 x 30 | archival board, 240, light grey |
| 0482 | A5, DIN 821-C | 225 x 185 x 30 | archival board, 240, light grey |
| <i>Juris folder for size A4</i> | | | |
| 0485 | A4 | 318 x 230 x 30 | archival board, 240, light grey |
| 04853 | A4 | 318 x 230 x 30 | archival board, 330, light grey |
| 048534 | A4, DIN 821-C | 318 x 230 x 30 | archival board, 330, light grey |
| <i>Juris folder for size folio</i> | | | |
| 0484 | folio | 345 x 230 x 30 | archival board, 240, light grey |
| 04843 | folio | 345 x 230 x 30 | archival board, 330, light grey |
| <i>Juris folder for size large folio</i> | | | |
| 04823401 | large folio | 370 x 250 x 30 | archival board, 240, light grey |
| 04823402 | large folio | 370 x 250 x 30 | archival board, 330, light grey |
| <i>Juris folder for size A3</i> | | | |
| 0483 | A3 | 430 x 320 x 30 | archival board, 240, light grey |
| 04873 | A3 | 430 x 320 x 30 | archival board, 330, light grey |
| <i>Juris folder for size A2</i> | | | |
| 04834802 | A2, DIN 821-C | 605 x 430 x 30 | archival board, 330, light grey |
| <i>Juris folder for size A1</i> | | | |
| 04834912 | A1 | 850 x 600 x 15 | archival board, 330, light grey |
| | | | |
| | | | |
| | | | |
| | | | |
| | | | |
| | | | |
| | | | |

Unit = packaging unit ; H = height ; W = width ; T = thickness ; D = depth ; L = length

5. Folders

5.4 Expansion folders

Juris folders (standard assortment available at short notice)

The following items are manufactured to order.

| Item | For size (cm) design | Int. dimensions H x W x T (mm) | Material, weight (gsm), colour |
|-------------|-------------------------|-----------------------------------|---------------------------------|
| 04820243 | DIN 821-C | 130 x 90 x 30 | archival board, 240, light grey |
| 04820241 | DIN 821-C | 130 x 90 x 30 | archival board, 330, light grey |
| 01170101 | 16 x 11.5 | 160 x 115 x 30 | archival board, 240, light grey |
| 01170202 | DIN 821-C | 160 x 117 x 30 | archival board, 240, light grey |
| 04830301 | DIN 821-C | 200 x 160 x 30 | archival board, 240, light grey |
| 04830302 | DIN 821-C | 200 x 160 x 30 | archival board, 330, light grey |
| 04813482 | DIN 821-C | 205 x 110 x 30 | archival board, 240, light grey |
| 04813582 | DIN 821-C | 205 x 110 x 30 | archival board, 330, light grey |
| 048105620/1 | DIN 821-C | 210 x 150 x 30 | archival board, 240, light grey |
| 048105620 | DIN 821-C | 210 x 150 x 30 | archival board, 330, light grey |
| 04820502 | A5 | 220 x 170 x 30 | archival board, 330, light grey |
| 04825795 | | 220 x 170 x 35 | archival board, 240, light grey |
| 04825895 | | 220 x 170 x 35 | archival board, 330, light grey |
| 048211 | A5, DIN 821-C | 225 x 185 x 30 | archival board, 330, light grey |
| 01170701 | | 230 x 160 x 50 | archival board, 240, light grey |
| 01170702 | | 230 x 160 x 50 | archival board, 330, light grey |
| 01170703 | | 230 x 162 x 50 | archival board, 240, light grey |
| 01170704 | | 230 x 162 x 50 | archival board, 330, light grey |
| 04820901 | DIN 821-C | 240 x 180 x 20 | archival board, 240, light grey |
| 04820902 | DIN 821-C | 240 x 180 x 20 | archival board, 330, light grey |
| 0483272 | DIN 821-C | 240 x 180 x 30 | archival board, 240, light grey |
| 0483271 | DIN 821-C | 240 x 180 x 30 | archival board, 330, light grey |
| 04821001 | DIN 821-C | 240 x 200 x 20 | archival board, 240, light grey |
| 04821002 | DIN 821-C | 240 x 200 x 20 | archival board, 330, light grey |
| 04831101 | | 240 x 200 x 30 | archival board, 240, light grey |
| 04831102 | | 240 x 200 x 30 | archival board, 330, light grey |
| 048721234 | | 243 x 182 x 20 | archival board, 240, light grey |

Unit = packaging unit ; H = height ; W = width ; T = thickness ; D = depth ; L = length

5. Folders

5.4 Expansion folders

Juris folders (standard assortment available at short notice)

The following items are manufactured to order.

| Item | For size design | Int. dimensions H x W x T (mm) | Material, weight (gsm), colour |
|-----------|-----------------|--------------------------------|---------------------------------|
| 0487212 | | 243 x 182 x 20 | archival board, 330, light grey |
| 04820903 | DIN 821-C | 245 x 170 x 10 | archival board, 240, light grey |
| 048209031 | DIN 821-C | 245 x 170 x 10 | archival board, 330, light grey |
| 0485573 | DIN 821-C | 245 x 195 x 6 | archival board, 240, light grey |
| 0485572 | DIN 821-C | 245 x 195 x 6 | archival board, 330, light grey |
| 04821201 | | 248 x 186 x 20 | archival board, 240, light grey |
| 04821202 | | 248 x 186 x 20 | archival board, 330, light grey |
| 04831301 | DIN 821-C | 250 x 180 x 30 | archival board, 240, light grey |
| 04831302 | DIN 821-C | 250 x 180 x 30 | archival board, 330, light grey |
| 04825781 | | 250 x 180 x 35 | archival board, 240, light grey |
| 04825881 | | 250 x 180 x 35 | archival board, 330, light grey |
| 04831303 | DIN 821-C | 250 x 186 x 30 | archival board, 240, light grey |
| 04831304 | DIN 821-C | 250 x 186 x 30 | archival board, 330, light grey |
| 04831401 | | 265 x 220 x 30 | archival board, 240, light grey |
| 04831402 | | 265 x 220 x 30 | archival board, 330, light grey |
| 04831403 | | 270 x 170 x 30 | archival board, 240, light grey |
| 04831404 | | 270 x 170 x 30 | archival board, 330, light grey |
| 04857834 | | 285 x 225 x 30 | archival board, 240, light grey |
| 04857934 | | 285 x 225 x 30 | archival board, 330, light grey |
| 04821701 | | 305 x 220 x 50 | archival board, 240, light grey |
| 04821702 | | 305 x 220 x 50 | archival board, 330, light grey |
| 04831901 | | 305 x 230 x 30 | archival board, 240, light grey |
| 04831902 | | 305 x 230 x 30 | archival board, 330, light grey |
| 04812127 | | 310 x 220 x 25 | archival board, 240, light grey |
| 04846834 | | 310 x 220 x 25 | archival board, 330, light grey |
| 04853728 | | 310 x 220 x 30 | archival board, 240, light grey |
| 04853723 | | 310 x 220 x 30 | archival board, 330, light grey |

Unit = packaging unit ; H = height ; W = width ; T = thickness ; D = depth ; L = length

5. Folders

5.4 Expansion folders

Juris folders (standard assortment available at short notice)

The following items are manufactured to order.

| Item | For size design | Int. dimensions H x W x T (mm) | Material, weight (gsm), colour |
|-----------|-----------------|-----------------------------------|---------------------------------|
| 04825741 | | 310 x 225 x 35 | archival board, 240, light grey |
| 04825742 | | 310 x 225 x 35 | archival board, 330, light grey |
| 04853786 | | 310 x 230 x 60 | archival board, 240, light grey |
| 04853776 | | 310 x 230 x 60 | archival board, 330, light grey |
| 04821204 | DIN 821-C | 310 x 235 x 10 | archival board, 240, light grey |
| 04821203 | DIN 821-C | 310 x 235 x 10 | archival board, 330, light grey |
| 04871959 | | 310 x 265 x 55 | archival board, 240, light grey |
| 04872059 | | 310 x 265 x 55 | archival board, 330, light grey |
| 048532 | A4, DIN 821-C | 318 x 230 x 30 | archival board, 240, light grey |
| 048531 | A4, DIN 821-C | 318 x 230 x 50 | archival board, 240, light grey |
| 048533 | A4, DIN 821-C | 318 x 230 x 50 | archival board, 330, light grey |
| 04832001 | | 320 x 240 x 40 | archival board, 240, light grey |
| 04832003 | | 320 x 240 x 40 | archival board, 330, light grey |
| 048719320 | | 320 x 240 x 150 | archival board, 240, light grey |
| 048720320 | | 320 x 240 x 150 | archival board, 330, light grey |
| 0485431 | DIN 821-C | 320 x 245 x 60 | archival board, 240, light grey |
| 0485331 | DIN 821-C | 320 x 245 x 60 | archival board, 330, light grey |
| 04810644 | | 320 x 330 x 15 | archival board, 240, light grey |
| 04810645 | | 320 x 330 x 15 | archival board, 330, light grey |
| 0485378 | | 328 x 240 x 30 | archival board, 240, light grey |
| 0485377 | | 328 x 240 x 30 | archival board, 330, light grey |
| 04832002 | DIN 821-C | 340 x 230 x 35 | archival board, 240, light grey |
| 04832004 | DIN 821-C | 340 x 230 x 35 | archival board, 330, light grey |
| 04842934 | Folio | 345 x 230 x 20 | archival board, 240, light grey |
| 04843034 | Folio | 345 x 230 x 20 | archival board, 330, light grey |
| 04824303 | | 345 x 245 x 30 | archival board, 240, light grey |
| 0482430 | | 345 x 245 x 30 | archival board, 330, light grey |

Unit = packaging unit ; H = height ; W = width ; T = thickness ; D = depth ; L = length

5. Folders

5.4 Expansion folders

Juris folders (standard assortment available at short notice)

The following items are manufactured to order.

| Item | For size design | Int. dimensions H x W x T (mm) | Material, weight (gsm), colour |
|----------|-----------------|-----------------------------------|---------------------------------|
| 04812128 | | 350 x 230 x 25 | archival board, 240, light grey |
| 04814588 | | 350 x 230 x 25 | archival board, 330, light grey |
| 04886222 | | 350 x 230 x 30 | archival board, 240, light grey |
| 04886223 | | 350 x 230 x 30 | archival board, 330, light grey |
| 04832201 | | 350 x 230 x 54 | archival board, 240, light grey |
| 04832202 | | 350 x 230 x 54 | archival board, 330, light grey |
| 0484120 | | 350 x 230 x 120 | archival board, 240, light grey |
| 0484220 | | 350 x 230 x 120 | archival board, 330, light grey |
| 04832203 | DIN 821-C | 350 x 240 x 1 | archival board, 240, light grey |
| 04832204 | DIN 821-C | 350 x 240 x 1 | archival board, 330, light grey |
| 04887533 | | 350 x 240 x 60 | archival board, 240, light grey |
| 04886533 | | 350 x 240 x 60 | archival board, 330, light grey |
| 048843 | | 350 x 250 x 40 | archival board, 240, light grey |
| 048833 | | 350 x 250 x 40 | archival board, 330, light grey |
| 048832 | | 350 x 250 x 50 | archival board, 530, light grey |
| 04820534 | DIN 821-C | 355 x 288 x 1 | archival board, 240, light grey |
| 04820537 | DIN 821-C | 355 x 288 x 1 | archival board, 330, light grey |
| 04832301 | DIN 821-C | 360 x 220 x 30 | archival board, 240, light grey |
| 04832302 | DIN 821-C | 360 x 220 x 30 | archival board, 330, light grey |
| 04832403 | DIN 821-C | 360 x 220 x 55 | archival board, 240, light grey |
| 04832303 | DIN 821-C | 360 x 220 x 55 | archival board, 330, light grey |
| 04832501 | | 360 x 240 x 25 | archival board, 240, light grey |
| 04832502 | | 360 x 240 x 25 | archival board, 330, light grey |
| 04832505 | | 360 x 240 x 30 | archival board, 240, light grey |
| 04832503 | | 360 x 240 x 30 | archival board, 330, light grey |
| 04822401 | DIN 821-C | 360 x 240 x 50 | archival board, 240, light grey |
| 04822402 | DIN 821-C | 360 x 240 x 50 | archival board, 330, light grey |

Unit = packaging unit ; H = height ; W = width ; T = thickness ; D = depth ; L = length

5. Folders

5.4 Expansion folders

Juris folders (standard assortment available at short notice)

The following items are manufactured to order.

| Item | For size design | Int. dimensions H x W x T (mm) | Material, weight (gsm), colour |
|----------|-----------------|--------------------------------|---------------------------------|
| 04832701 | DIN 821-C | 360 x 240 x 50 | archival board, 530, light grey |
| 04822801 | | 360 x 240 x 55 | archival board, 240, light grey |
| 04822802 | | 360 x 240 x 55 | archival board, 330, light grey |
| 04832601 | | 360 x 245 x 40 | archival board, 240, light grey |
| 04832602 | | 360 x 245 x 40 | archival board, 330, light grey |
| 04853824 | | 360 x 245 x 60 | archival board, 240, light grey |
| 04853724 | | 360 x 245 x 60 | archival board, 330, light grey |
| 04853926 | | 360 x 245 x 90 | archival board, 240, light grey |
| 04853826 | | 360 x 245 x 90 | archival board, 330, light grey |
| 04810112 | | 360 x 250 x 30 | archival board, 240, light grey |
| 04810113 | | 360 x 250 x 30 | archival board, 330, light grey |
| 04832901 | DIN 821-C | 360 x 260 x 30 | archival board, 240, light grey |
| 04832902 | DIN 821-C | 360 x 260 x 30 | archival board, 330, light grey |
| 04813513 | DIN 821-C | 360 x 272 x 1 | archival board, 240, light grey |
| 04813512 | DIN 821-C | 360 x 272 x 1 | archival board, 330, light grey |
| 04872010 | DIN 821-C | 360 x 300 x 1 | archival board, 240, light grey |
| 04872078 | DIN 821-C | 360 x 300 x 1 | archival board, 330, light grey |
| 01174364 | | 364 x 249 x 40 | archival board, 240, light grey |
| 01174365 | | 364 x 249 x 40 | archival board, 330, light grey |
| 01178504 | | 364 x 249 x 80 | archival board, 240, light grey |
| 01177504 | | 364 x 249 x 80 | archival board, 330, light grey |
| 04823201 | | 365 x 240 x 50 | archival board, 240, light grey |
| 04823202 | | 365 x 240 x 50 | archival board, 330, light grey |
| 01173101 | | 365 x 245 x 50 | archival board, 240, light grey |
| 01173102 | | 365 x 245 x 50 | archival board, 330, light grey |
| 04810014 | DIN 821-C | 365 x 297 x 5 | archival board, 240, light grey |
| 04810015 | DIN 821-C | 365 x 297 x 5 | archival board, 330, light grey |

Unit = packaging unit ; H = height ; W = width ; T = thickness ; D = depth ; L = length

5. Folders

5.4 Expansion folders

Juris folders (standard assortment available at short notice)

The following items are manufactured to order.

| Item | For size design | Int. dimensions H x W x T (mm) | Material, weight (gsm), colour |
|----------|-----------------|--------------------------------|---------------------------------|
| 04864394 | DIN 821-C | 365 x 297 x 8 | archival board, 240, light grey |
| 04864395 | DIN 821-C | 365 x 297 x 8 | archival board, 330, light grey |
| 04848348 | DIN 821-C | 365 x 297 x 10 | archival board, 240, light grey |
| 04848349 | DIN 821-C | 365 x 297 x 10 | archival board, 330, light grey |
| 04832707 | | 365 x 297 x 30 | archival board, 240, light grey |
| 04832704 | | 365 x 297 x 30 | archival board, 330, light grey |
| 04832713 | | 365 x 297 x 50 | archival board, 240, light grey |
| 04832703 | | 365 x 297 x 50 | archival board, 330, light grey |
| 0481311 | | 370 x 125 x 50 | archival board, 240, light grey |
| 0481211 | | 370 x 125 x 50 | archival board, 330, light grey |
| 04853501 | DIN 821-C | 370 x 250 x 40 | archival board, 530, light grey |
| 04872077 | | 370 x 250 x 60 | archival board, 240, light grey |
| 04872177 | | 370 x 250 x 60 | archival board, 330, light grey |
| 04853601 | | 370 x 260 x 20 | archival board, 530, light grey |
| 04823701 | | 370 x 260 x 30 | archival board, 240, light grey |
| 04823702 | | 370 x 260 x 30 | archival board, 330, light grey |
| 04833801 | DIN 821-C | 370 x 290 x 30 | archival board, 240, light grey |
| 04833802 | DIN 821-C | 370 x 290 x 30 | archival board, 330, light grey |
| 04833371 | DIN 821-C | 370 x 390 x 30 | archival board, 240, light grey |
| 04833370 | DIN 821-C | 370 x 390 x 30 | archival board, 330, light grey |
| 04853752 | | 380 x 250 x 30 | archival board, 240, light grey |
| 04843843 | | 380 x 250 x 30 | archival board, 330, light grey |
| 04810555 | | 380 x 250 x 77 | archival board, 530, light grey |
| 04840103 | | 380 x 255 x 50 | archival board, 240, light grey |
| 04839103 | | 380 x 255 x 50 | archival board, 330, light grey |
| 04872030 | DIN 821-C | 380 x 260 x 1 | archival board, 240, light grey |
| 04872022 | DIN 821-C | 380 x 260 x 1 | archival board, 330, light grey |

Unit = packaging unit ; H = height ; W = width ; T = thickness ; D = depth ; L = length

5. Folders

5.4 Expansion folders

Juris folders (standard assortment available at short notice)

The following items are manufactured to order.

| Item | For size design | Int. dimensions H x W x T (mm) | Material, weight (gsm), colour |
|----------|-----------------|-----------------------------------|---------------------------------|
| 0487220 | | 380 x 270 x 30 | archival board, 240, light grey |
| 0487209 | | 380 x 270 x 30 | archival board, 330, light grey |
| 04871948 | | 380 x 275 x 30 | archival board, 240, light grey |
| 04872048 | | 380 x 275 x 30 | archival board, 330, light grey |
| 04872088 | | 380 x 280 x 60 | archival board, 240, light grey |
| 04872098 | | 380 x 280 x 60 | archival board, 330, light grey |
| 04831676 | DIN 821-C | 380 x 290 x 35 | archival board, 240, light grey |
| 04831675 | DIN 821-C | 380 x 290 x 35 | archival board, 330, light grey |
| 04820034 | DIN 821-C | 380 x 300 x 20 | archival board, 240, light grey |
| 04820033 | DIN 821-C | 380 x 300 x 20 | archival board, 330, light grey |
| 04821501 | | 385 x 260 x 50 | archival board, 240, light grey |
| 04821301 | | 385 x 260 x 50 | archival board, 330, light grey |
| 04823901 | | 385 x 275 x 30 | archival board, 240, light grey |
| 04823902 | | 385 x 275 x 30 | archival board, 330, light grey |
| 04871037 | | 390 x 240 x 10 | archival board, 240, light grey |
| 04872037 | | 390 x 240 x 10 | archival board, 330, light grey |
| 04872032 | | 390 x 290 x 30 | archival board, 240, light grey |
| 04872014 | | 390 x 290 x 30 | archival board, 330, light grey |
| 04824001 | | 390 x 330 x 5 | archival board, 240, light grey |
| 04824002 | | 390 x 330 x 5 | archival board, 330, light grey |
| 04834101 | DIN 821-C | 395 x 310 x 30 | archival board, 240, light grey |
| 04834102 | DIN 821-C | 395 x 310 x 30 | archival board, 330, light grey |
| 04824301 | | 400 x 280 x 30 | archival board, 240, light grey |
| 04824302 | | 400 x 280 x 30 | archival board, 330, light grey |
| 04822101 | DIN 821-C | 400 x 330 x 1 | archival board, 240, light grey |
| 04822102 | DIN 821-C | 400 x 330 x 1 | archival board, 330, light grey |
| 04822105 | DIN 821-C | 420 x 265 x 30 | archival board, 240, light grey |

Unit = packaging unit ; H = height ; W = width ; T = thickness ; D = depth ; L = length

5. Folders

5.4 Expansion folders

Juris folders (standard assortment available at short notice)

The following items are manufactured to order.

| Item | For size design | Int. dimensions H x W x T (mm) | Material, weight (gsm), colour |
|-----------|-----------------|-----------------------------------|---------------------------------|
| 04822104 | DIN 821-C | 420 x 265 x 30 | archival board, 330, light grey |
| 04824501 | | 430 x 280 x 30 | archival board, 240, light grey |
| 04824502 | | 430 x 280 x 30 | archival board, 330, light grey |
| 04820201 | | 430 x 300 x 60 | archival board, 240, light grey |
| 04820101 | | 430 x 300 x 60 | archival board, 330, light grey |
| 04872437 | DIN 821-C | 430 x 310 x 4 | archival board, 240, light grey |
| 04872438 | DIN 821-C | 430 x 310 x 4 | archival board, 330, light grey |
| 04825823 | | 430 x 320 x 35 | archival board, 240, light grey |
| 04825723 | | 430 x 320 x 35 | archival board, 330, light grey |
| 048720056 | DIN 821-C | 435 x 365 x 1 | archival board, 240, light grey |
| 04872005 | DIN 821-C | 435 x 365 x 1 | archival board, 330, light grey |
| 04872114 | DIN 821-C | 440 x 310 x 10 | archival board, 240, light grey |
| 04872112 | DIN 821-C | 440 x 310 x 10 | archival board, 330, light grey |
| 04853927 | | 440 x 330 x 105 | archival board, 240, light grey |
| 04853827 | | 440 x 330 x 105 | archival board, 330, light grey |
| 04825503 | | 445 x 315 x 30 | archival board, 240, light grey |
| 04825502 | | 445 x 315 x 30 | archival board, 330, light grey |
| 04871046 | | 490 x 430 x 10 | archival board, 240, light grey |
| 04872046 | | 490 x 430 x 10 | archival board, 330, light grey |
| 048245031 | DIN 821-C | 498 x 358 x 30 | archival board, 240, light grey |
| 0489749 | DIN 821-C | 498 x 358 x 30 | archival board, 330, light grey |
| 048349012 | DIN 821-C | 500 x 350 x 1 | archival board, 240, light grey |
| 048349011 | DIN 821-C | 500 x 350 x 1 | archival board, 330, light grey |
| 04834901 | DIN 821-C | 500 x 400 x 1 | archival board, 240, light grey |
| 04834902 | DIN 821-C | 500 x 400 x 1 | archival board, 330, light grey |
| 048858 | DIN 821-C | 500 x 400 x 20 | archival board, 240, light grey |
| 048857 | DIN 821-C | 500 x 400 x 20 | archival board, 330, light grey |

Unit = packaging unit ; H = height ; W = width ; T = thickness ; D = depth ; L = length

5. Folders

5.4 Expansion folders

Juris folders (standard assortment available at short notice)

The following items are manufactured to order.

| Item | For size design | Int. dimensions H x W x T (mm) | Material, weight (gsm), colour |
|-----------|-----------------|-----------------------------------|---------------------------------|
| 04837003 | | 525 x 370 x 30 | archival board, 240, light grey |
| 04837001 | | 525 x 370 x 30 | archival board, 330, light grey |
| 048251021 | DIN 821-C | 530 x 365 x 10 | archival board, 240, light grey |
| 048251023 | DIN 821-C | 530 x 365 x 10 | archival board, 330, light grey |
| 04872505 | | 545 x 375 x 30 | archival board, 240, light grey |
| 04872405 | | 545 x 375 x 30 | archival board, 330, light grey |
| 048720115 | DIN 821-C | 560 x 360 x 5 | archival board, 240, light grey |
| 048720113 | DIN 821-C | 560 x 360 x 5 | archival board, 330, light grey |
| 04834701 | DIN 821-C | 560 x 400 x 20 | archival board, 330, light grey |
| 0481036 | DIN 821-C | 575 x 440 x 1 | archival board, 240, light grey |
| 0481037 | DIN 821-C | 575 x 440 x 1 | archival board, 330, light grey |
| 04810370 | | 575 x 445 x 10 | archival board, 240, light grey |
| 04810371 | | 575 x 445 x 10 | archival board, 330, light grey |
| 04835001 | DIN 821-C | 600 x 500 x 1 | archival board, 240, light grey |
| 04835002 | DIN 821-C | 600 x 500 x 1 | archival board, 330, light grey |
| 04835004 | DIN 821-C | 600 x 500 x 30 | archival board, 240, light grey |
| 0484629 | DIN 821-C | 600 x 500 x 30 | archival board, 330, light grey |
| 04834801 | A2, DIN 821-C | 605 x 430 x 30 | archival board, 240, light grey |
| 04816740 | DIN 821-C | 610 x 410 x 10 | archival board, 240, light grey |
| 04816741 | DIN 821-C | 610 x 410 x 10 | archival board, 330, light grey |
| 0483392 | DIN 821-C | 655 x 460 x 30 | archival board, 240, light grey |
| 0483391 | DIN 821-C | 655 x 460 x 30 | archival board, 330, light grey |
| 04821532 | DIN 821-C | 860 x 620 x 1 | archival board, 240, light grey |
| 04821531 | DIN 821-C | 860 x 620 x 1 | archival board, 330, light grey |
| | | | |
| | | | |
| | | | |

Unit = packaging unit ; H = height ; W = width ; T = thickness ; D = depth ; L = length

6. Enclosures

6.1 Transparent

Envelopes – U-style



Photographic envelope enclosures in U-style, made from transparent archival paper without an alkaline buffer. The envelope opening is on the longer side. Suitable for archiving photographs, negatives and glass slides. Other sizes available upon request.

Both, the paper and glue have passed the Photographic Activity Test (PAT) in accordance with ISO 18916.

| Item | For size (cm) | Dimensions H/H x W (mm) | Envelopes/unit | Material, weight (gsm), colour |
|------|---------------|-------------------------|----------------|---------------------------------|
| 1211 | 9 x 12 | 105/95 x 125 | 1000 | archival paper, 40, transparent |
| 1212 | 9 x 13 | 105/95 x 135 | 1000 | archival paper, 40, transparent |
| 1213 | 10 x 15 | 115/105 x 155 | 1000 | archival paper, 40, transparent |
| 1214 | 12 x 16.5 | 127/123 x 170 | 1000 | archival paper, 40, transparent |
| 1215 | 13 x 18 | 145/135 x 190 | 1000 | archival paper, 40, transparent |
| 1216 | 18 x 24 | 192/188 x 250 | 1000 | archival paper, 50, transparent |
| 1204 | A4 | 230/220 x 310 | 500 | archival paper, 50, transparent |
| 1217 | 24 x 30 | 255/245 x 310 | 1000 | archival paper, 50, transparent |
| 1218 | 30 x 40 | 315/305 x 410 | 500 | archival paper, 50, transparent |
| 1203 | A3 | 315/305 x 440 | 500 | archival paper, 50, transparent |

Unit = packaging unit ; H = height ; W = width ; T = thickness ; D = depth ; L = length

6. Enclosures

6.2 Opaque

Folder enclosures with inscription flap



Folder enclosures made from opaque photographic archival paper without an alkaine buffer. The enclosure is open on three sides and has a 10 mm longer back flap for inscription purposes. Suitable for the archival storage of prints, negatives, glass plates etc. Other sizes available on request.

The paper has passed the Photographic Activity Test (PAT) in accordance with ISO 18916.

| Item | For size (cm) | Dimensions H/H x W (mm) | Folder/unit | Material, weight (gsm), colour |
|------|---------------|-------------------------|-------------|---|
| 4112 | 9 x 13 | 115/105 x 135 | 1000 | photographic archival paper, 120, natural white |
| 4113 | 10 x 15 | 125/115 x 156 | 1000 | photographic archival paper, 120, natural white |
| 4115 | 13 x 18 | 144/134 x 185 | 1000 | photographic archival paper, 120, natural white |
| 4116 | 18 x 24 | 192/182 x 250 | 1000 | photographic archival paper, 120, natural white |
| 4117 | 24 x 30 | 257/247 x 310 | 500 | photographic archival paper, 120, natural white |
| 4118 | 30 x 40 | 325/315 x 410 | 500 | photographic archival paper, 120, natural white |
| | | | | |
| | | | | |
| | | | | |
| | | | | |
| | | | | |
| | | | | |
| | | | | |
| | | | | |
| | | | | |
| | | | | |
| | | | | |
| | | | | |
| | | | | |
| | | | | |
| | | | | |

Unit = packaging unit ; H = height ; W = width ; T = thickness ; D = depth ; L = length

6. Enclosures

6.2 Opaque

Four flap folders



Seamless, four flap folder enclosures made from a single sheet of opaque photographic archival paper without an alkaline buffer. These folder enclosures are especially suitable for archiving glass plates, valuable photographs and negatives. Other sizes on request.

The photographic paper has passed the Photographic Activity Test (PAT) in accordance with ISO 18916.

| Item | For size (cm) | Int. dimensions W x H (mm) | Ext. dimensions W x H (mm) | Folder/unit | Material, weight (gsm), colour |
|------|---------------|----------------------------|----------------------------|-------------|---|
| 5173 | 4.5 x 6.5 | 46 x 66 | 47 x 67 | 500 | photographic archival paper, 120, natural white |
| 5105 | 6 x 9 | 62 x 92 | 63 x 93 | 500 | photographic archival paper, 120, natural white |
| 5110 | 8.5 x 10 | 87 x 102 | 88 x 103 | 500 | photographic archival paper, 120, natural white |
| 5111 | 9 x 12 | 91 x 121 | 92 x 122 | 500 | photographic archival paper, 120, natural white |
| 5112 | 9 x 13 | 92 x 130 | 93 x 131 | 500 | photographic archival paper, 120, natural white |
| 5113 | 10 x 15 | 101 x 151 | 102 x 152 | 500 | photographic archival paper, 120, natural white |
| 5115 | 13 x 18 | 131 x 181 | 132 x 182 | 500 | photographic archival paper, 120, natural white |
| 5116 | 18 x 24 | 181 x 241 | 182 x 242 | 500 | photographic archival paper, 120, natural white |
| 5117 | 24 x 30 | 241 x 301 | 242 x 302 | 100 | photographic archival paper, 120, natural white |
| 5118 | 30 x 40 | 301 x 401 | 302 x 402 | 100 | photographic archival paper, 120, natural white |
| | | | | | |
| | | | | | |
| | | | | | |
| | | | | | |
| | | | | | |
| | | | | | |
| | | | | | |
| | | | | | |
| | | | | | |
| | | | | | |
| | | | | | |
| | | | | | |
| | | | | | |
| | | | | | |
| | | | | | |
| | | | | | |
| | | | | | |
| | | | | | |
| | | | | | |
| | | | | | |
| | | | | | |
| | | | | | |
| | | | | | |
| | | | | | |
| | | | | | |
| | | | | | |
| | | | | | |
| | | | | | |
| | | | | | |
| | | | | | |
| | | | | | |
| | | | | | |
| | | | | | |
| | | | | | |
| | | | | | |
| | | | | | |

Unit = packaging unit ; H = height ; W = width ; T = thickness ; D = depth ; L = length

6. Enclosures

6.2 Opaque

Envelopes – U-style



These U-style, ageing-resistant envelope enclosures have especially been developed for archiving photographs, microfiches, glass plates and film negatives. The envelopes are available with or without an alkaline buffer, in natural white or white coloured photographic archival paper. The enclosure opening is on the longer side. Other sizes upon request.

Both, the photographic paper and glue have passed the Photographic Activity Test (PAT) in accordance with ISO 18916.

| Item | For size (cm) design | Ext. dimensions H/H x W (mm) | Envelopes/ unit | Material, weight (gsm), colour |
|---|-------------------------|---------------------------------|--------------------|---|
| <i>Envelopes made from photographic archival paper with an alkaline buffer</i> | | | | |
| 2090 | microfiches | 92/107 x 154 | 1000 | photographic archival paper, 90, white |
| <i>Envelopes made from photographic archival paper without an alkaline buffer</i> | | | | |
| 3121 | 35mm film | 51 x 251 | 1000 | photographic archival paper, 120, natural white |
| 3122 | 6 x 6 | 76 x 273 | 1000 | photographic archival paper, 120, natural white |
| 1111 | 9 x 12 | 105/95 x 125 | 1000 | photographic archival paper, 120, natural white |
| 1112 | 9 x 13 | 105/95 x 135 | 500 | photographic archival paper, 120, natural white |
| 1113 | 10 x 15 | 115/105 x 155 | 500 | photographic archival paper, 120, natural white |
| 1115 | 13 x 18 | 145/135 x 190 | 500 | photographic archival paper, 120, natural white |
| 1116 | 18 x 24 | 192/188 x 250 | 500 | photographic archival paper, 120, natural white |
| 1117 | 24 x 30 | 255/245 x 310 | 500 | photographic archival paper, 120, natural white |
| 1118 | 30 x 40 | 315/305 x 410 | 500 | photographic archival paper, 120, natural white |
| | | | | |
| | | | | |
| | | | | |
| | | | | |
| | | | | |
| | | | | |
| | | | | |
| | | | | |
| | | | | |
| | | | | |
| | | | | |
| | | | | |

Unit = packaging unit ; H = height ; W = width ; T = thickness ; D = depth ; L = length

6. Enclosures

6.3 Binder pocket pages

w. binder-edge, made from transparent paper

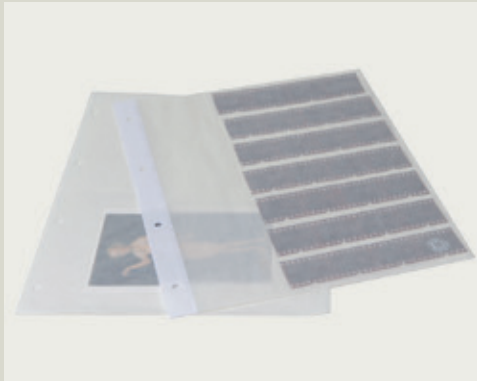

Binder pocket pages made from transparent archival paper without an alkaline buffer, with reinforced, standard 4-hole binder-edges. Available for 35 mm and 6 x 6 cm negative strips (pocket opening on the side), for A4/A6 sizes and standard photo sizes (pocket opening on top). Other sizes on request. Both, paper and glue have passed the Photographic Activity Test (PAT) in accordance with ISO 18916.

| Item | For size (cm/inch) | Pocket dimens. H x W (mm) | Page dimens. H x W (mm) | Pages/ unit | Material, weight (gsm), colour |
|------|--|------------------------------|----------------------------|----------------|---------------------------------|
| 3222 | 4 pockets 6 x 6 cm, 6 x 9 cm (negative strips) | 70 x 185 | 305 x 215 | 1000 | archival paper, 40, transparent |
| 3204 | 1 pocket 18 x 24 cm, 8 x 10", A4 | 300 x 210 | 305 x 235 | 1000 | archival paper, 40, transparent |
| 3221 | 7 pockets 35 mm-film (negative strips) | 35 x 225 | 305 x 252 | 1000 | archival paper, 40, transparent |
| 3226 | 4 pockets 9 x 12 cm, 9 x 13 cm, 3.5 x 5" | 142 x 100 | 310 x 238 | 1000 | archival paper, 40, transparent |
| 3225 | 2 pockets 10 x 15 cm, 13 x 18 cm, A6 4 x 6", 5 x 7" | 145 x 197 | 310 x 238 | 1000 | archival paper, 40, transparent |

6.3 Binder pocket pages

w. binder-edge, made from opaque paper



Binder pocket pages made from opaque archival paper without an alkaline buffer, with reinforced, standard 4-hole binder-edges. Available for A5/A6 sizes and for standard photo sizes (pocket opening on top). Other sizes on request. Both, paper and glue have passed the Photographic Activity Test (PAT) in accordance with ISO 18916.

| Item | For size (cm/inch) | Pocket dimens. H x W (mm) | Page dimens. H x W (mm) | Pages/ unit | Material, weight (gsm), colour |
|---------|--|------------------------------|----------------------------|----------------|--------------------------------|
| 3225-10 | 2 pockets 13 x 18 cm, 10 x 15 cm, A6 5 x 7", 4 x 6" | 185 x 136 | 303 x 210 | 500 | archival paper, 90, opaque |
| 3225-12 | 1 pocket 18 x 24 cm, A5, 6 x 8" | 293 x 185 | 303 x 210 | 500 | archival paper, 90, opaque |
| | | | | | |
| | | | | | |

Unit = packaging unit ; H = height ; W = width ; T = thickness ; D = depth ; L = length

6. Enclosures

6.4 Envelopes for documents

made from archival paper

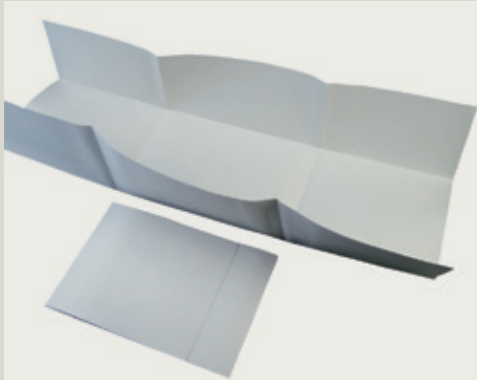

An envelope enclosure closed on all sides and thus with no loss of fragments. Ideal for archiving legal documents, certificates, manuscripts etc. The envelope is folded together, four-sided, from a single sheet of light grey or grey-blue archival paper, 130 gsm. Due to special surface treatment dirt-resistant, erasable and rub-proof (dry wiping). Other sizes on request.(dry wiping). Other sizes upon request.

| Item | Design | Int. dimensions L x W x H (mm) | Ext. dimensions L x W x H (mm) | Material, weight (gsm), colour |
|---------|----------------------------|-----------------------------------|-----------------------------------|---------------------------------|
| 941151 | folded from a single sheet | 260 x 180 x 2 | 261 x 181 x 3 | archival paper, 130, light grey |
| 9411511 | folded from a single sheet | 260 x 180 x 2 | 261 x 181 x 3 | archival paper, 130, grey-blue |
| 941152 | folded from a single sheet | 325 x 230 x 2 | 326 x 231 x 3 | archival paper, 130, light grey |
| 9411521 | folded from a single sheet | 325 x 230 x 2 | 326 x 231 x 3 | archival paper, 130, grey-blue |
| | | | | |
| | | | | |
| | | | | |

6.4 Envelopes for documents

made from archival board



An envelope enclosure closed on all sides and thus with no loss of fragments. Ideal for archiving legal documents, certificates, manuscripts etc. A very compact archiving method for minimum space requirement. The envelope enclosure is made from light grey coloured archival board, 240 gsm. Due to special surface treatment dirt-resistant, erasable and rub-proof (dry wiping). Other sizes on request.

| Item | Design | Int. dimensions L x W x H (mm) | Ext. dimensions L x W x H (mm) | Material, weight (gsm), colour |
|--------|-------------------|-----------------------------------|-----------------------------------|---------------------------------|
| 941150 | closed all around | 220 x 340 x 40 | 221 x 341 x 41 | archival board, 240, light grey |
| | | | | |
| | | | | |
| | | | | |
| | | | | |

Unit = packaging unit ; H = height ; W = width ; T = thickness ; D = depth ; L = length

6. Enclosures

6.5 Seal bags

A protective bag made from permeable, ageing-resistant, pure polyester fleece, for attached, removed or hanging pendant type seals. The polyester bag provides maximum protection against damages caused by pressure implementation, wear and tear, scratches, dirt and other impurities. **Please note:** Samples for sizes differing to our standard assortment are not available.



| Item | Thickness (mm) | Covering size ²⁾ (cm) | Seal diameter (Ø in mm) | Weight (gsm) | Coverings/unit | Colour |
|---------|----------------|----------------------------------|-------------------------|--------------|----------------|--------|
| 9411601 | 2.0 | 5.1 x 6.1 | 35 | 300 | 100 | white |
| 941160 | 2.0 | 7.1 x 6.1 | 45 | 300 | 100 | white |
| 941165 | 2.0 | 8.6 x 7.3 | 55 | 300 | 100 | white |
| 941170 | 2.0 | 10.6 x 9.0 | 70 | 300 | 100 | white |
| 941175 | 2.0 | 11.6 x 9.9 | 80 | 300 | 100 | white |
| 941180 | 2.0 | 13.0 x 11.0 | 90 | 300 | 100 | white |

Shts. = sheets ; unit = packaging unit ; ¹⁾ cuttings to size, extra cost ; ²⁾ cuttings not possible ; ³⁾ without 4-sided angular cut ; ⁴⁾ units packed in poly bags

7. Boxes

7.1 Wraparound boxes

KS 1



A simple and reasonably priced folder type, wraparound box for storing books, archival material and other objects. Often used for exhibition transports.

| Item | For size (cm) | Int. dimensions H x W x T (mm) | Ext. dimensions H x W x T (mm) | Material (mm) | Colour (exterior) |
|-----------|---------------|--------------------------------|--------------------------------|---------------|-------------------|
| 2119001 | 20 x 25 | 250 x 200 x 40 | 254 x 204 x 46 | MW 1.6 | light grey |
| 216510301 | 20 x 25 | 250 x 200 x 40 | 254 x 204 x 46 | MW 1.65 | grey-blue |
| 2119101 | 20 x 25 | 250 x 200 x 80 | 254 x 204 x 86 | MW 1.6 | light grey |
| 216510401 | 20 x 25 | 250 x 200 x 80 | 254 x 204 x 86 | MW 1.65 | grey-blue |
| 2114901 | A4 | 302 x 215 x 40 | 306 x 219 x 46 | MW 1.6 | light grey |
| 216510201 | A4 | 302 x 215 x 40 | 306 x 219 x 46 | MW 1.65 | grey-blue |
| 2121001 | A4 | 307 x 228 x 14 | 311 x 232 x 20 | MW 1.6 | light grey |
| 216510501 | A4 | 307 x 228 x 14 | 311 x 232 x 20 | MW 1.65 | grey-blue |
| 3120001 | 30 x 35 | 350 x 300 x 70 | 358 x 308 x 82 | FW 3.0 | light grey |
| 3120101 | 30 x 35 | 350 x 300 x 120 | 358 x 308 x 132 | FW 3.0 | light grey |

MW = corrugated board E-flute ; FW = corrugated board B-flute ; H = height ; W = width ; T = thickness ; D = depth ; L = length

7. Boxes

7.1 Wraparound boxes

KS 2



A tightly closing folder type, wraparound box especially suitable for heavy books. The interior surfaces of the box are smooth and additional stability is achieved with a double-walled construction.

| Item | For size (cm) | Int. dimensions H x W x T (mm) | Ext. dimensions H x W x T (mm) | Material (mm) | Colour (exterior) |
|--------------|---------------|--------------------------------|--------------------------------|---------------|-------------------|
| upon request | | | | | |
| | | | | | |
| | | | | | |
| | | | | | |
| | | | | | |
| | | | | | |

7.1 Wraparound boxes

KS 11



A folder type, wraparound box very similar to the design of the KS 1 box, yet with an attached base insert. Suitable for books and other kinds of archival objects. The narrow closing flap does not touch the object being archived.

| Item | For size (cm) | Int. dimensions H x W x T (mm) | Ext. dimensions H x W x T (mm) | Material (mm) | Colour (exterior) |
|-----------|---------------|--------------------------------|--------------------------------|---------------|-------------------|
| 3121011 | A4/folio | 350 x 235 x 63 | 359 x 244 x 80 | FW 3.0 | light grey |
| 2110111 | | 360 x 250 x 10 | 363 x 257 x 21 | MW 1.6 | light grey |
| 216510111 | | 360 x 250 x 10 | 363 x 257 x 21 | MW 1.65 | grey-blue |
| | | | | | |
| | | | | | |
| | | | | | |

MW = corrugated board E-flute ; FW = corrugated board B-flute ; H = height ; W = width ; T = thickness ; D = depth ; L = length

7. Boxes

7.2 Clamshell boxes

KS 3



A tightly closing clamshell box suitable for the storage of books, photographic material and all sorts of loose and unbound objects. Available with or without insertion slits and with an additional base reinforcement. Our most popular archival box and bestseller.

| Item | For size (cm) | Int. dimensions H x W x T (mm) | Ext. dimensions H x W x T (mm) | Material (mm) | Colour (exterior) |
|-----------|----------------|--------------------------------|--------------------------------|---------------|-------------------|
| 2112003 | 9 x 12, 9 x 13 | 143 x 118 x 60 | 151 x 132 x 65 | MW 1.6 | light grey |
| 216511203 | 9 x 12, 9 x 13 | 143 x 118 x 60 | 151 x 132 x 65 | MW 1.65 | grey-blue |
| 2113003 | | 160 x 120 x 60 | 168 x 134 x 65 | MW 1.6 | light grey |
| 216511303 | | 160 x 120 x 60 | 168 x 134 x 65 | MW 1.65 | grey-blue |
| 2115103 | 13 x 18 | 192 x 146 x 40 | 200 x 160 x 45 | MW 1.6 | light grey |
| 216511603 | 13 x 18 | 192 x 146 x 40 | 200 x 160 x 45 | MW 1.65 | graublau |
| 2115203 | 13 x 18 | 195 x 146 x 60 | 203 x 160 x 65 | MW 1.6 | light grey |
| 216511803 | 13 x 18 | 195 x 146 x 60 | 203 x 160 x 65 | MW 1.65 | grey-blue |
| 2115003 | 13 x 18 | 197 x 157 x 43 | 205 x 171 x 48 | MW 1.6 | light grey |
| 216511403 | 13 x 18 | 197 x 157 x 43 | 205 x 171 x 48 | MW 1.65 | grey-blue |
| 2115303 | | 220 x 160 x 40 | 228 x 174 x 45 | MW 1.6 | light grey |
| 216511903 | | 220 x 160 x 40 | 228 x 174 x 45 | MW 1.65 | grey-blue |
| 2118303 | | 220 x 180 x 60 | 228 x 194 x 65 | MW 1.6 | light grey |
| 216513203 | | 220 x 180 x 60 | 228 x 194 x 65 | MW 1.65 | grey-blue |
| 2110103 | | 250 x 210 x 40 | 258 x 224 x 45 | MW 1.6 | light grey |
| 216510203 | | 250 x 210 x 40 | 258 x 224 x 45 | MW 1.65 | grey-blue |
| 2116003 | 18 x 24 | 253 x 195 x 60 | 261 x 209 x 65 | MW 1.6 | light grey |
| 216512003 | 18 x 24 | 253 x 195 x 60 | 261 x 209 x 65 | MW 1.65 | grey-blue |
| 2115101 | | 260 x 184 x 25 | 271 x 203 x 32 | MW 1.6 | light grey |
| 216511503 | | 260 x 184 x 25 | 271 x 203 x 32 | MW 1.65 | grey-blue |
| 2115201 | 18 x 24 | 260 x 184 x 40 | 271 x 203 x 47 | MW 1.6 | light grey |
| 216511703 | 18 x 24 | 260 x 184 x 40 | 271 x 203 x 47 | MW 1.65 | grey-blue |
| 2116103 | | 260 x 220 x 100 | 268 x 234 x 105 | MW 1.6 | light grey |
| 216512103 | | 260 x 220 x 100 | 268 x 234 x 105 | MW 1.65 | graublau |
| 2110203 | | 261 x 155 x 45 | 269 x 169 x 50 | MW 1.6 | light grey |
| 216510403 | | 261 x 155 x 45 | 269 x 169 x 50 | MW 1.65 | grey-blue |
| 2110216 | | 265 x 200 x 30 | 276 x 219 x 37 | MW 1.6 | light grey |

MW = corrugated board E-flute ; FW = corrugated board B-flute ; H = height ; W = width ; T = thickness ; D = depth ; L = length

7. Boxes

7.2 Clamshell boxes

KS 3

| Item | For size (cm) | Int. dimensions H x W x T (mm) | Ext. dimensions H x W x T (mm) | Material (mm) | Colour (exterior) |
|-----------|---------------|-----------------------------------|-----------------------------------|------------------|----------------------|
| 216510503 | | 265 x 200 x 30 | 276 x 219 x 37 | MW 1.65 | grey-blue |
| 216520803 | | 270 x 220 x 100 | 282 x 239 x 106 | MW 1.65 | grey-blue |
| 214700330 | | 270 x 220 x 100 | 282 x 239 x 106 | MW 1.7 | grey-blue |
| 2116203 | 18 x 24 | 275 x 220 x 70 | 283 x 234 x 75 | MW 1.6 | light grey |
| 216512203 | 18 x 24 | 275 x 220 x 70 | 283 x 234 x 75 | MW 1.65 | grey-blue |
| 2117003 | 24 x 30 | 300 x 240 x 30 | 308 x 254 x 35 | MW 1.6 | light grey |
| 216512303 | 24 x 30 | 300 x 240 x 30 | 308 x 254 x 35 | MW 1.65 | grey-blue |
| 2117603 | 24 x 30 | 300 x 240 x 60 | 308 x 254 x 65 | MW 1.6 | light grey |
| 216512803 | 24 x 30 | 300 x 240 x 60 | 308 x 254 x 65 | MW 1.65 | grey-blue |
| 2110303 | A4 | 302 x 215 x 75 | 310 x 229 x 80 | MW 1.6 | light grey |
| 216510603 | A4 | 302 x 215 x 75 | 310 x 229 x 80 | MW 1.65 | grey-blue |
| 216521703 | A4 | 307 x 217 x 100 | 319 x 236 x 106 | MW 1.65 | grey-blue |
| 214701403 | A4 | 307 x 217 x 100 | 319 x 236 x 106 | MW 1.7 | grey-blue |
| 216520703 | | 308 x 249 x 79 | 320 x 268 x 85 | MW 1.65 | grey-blue |
| 21470033 | | 308 x 249 x 79 | 320 x 268 x 85 | MW 1.7 | grey-blue |
| 2117103 | 24 x 30 | 310 x 250 x 30 | 318 x 254 x 35 | MW 1.6 | light grey |
| 216512403 | 24 x 30 | 310 x 250 x 30 | 318 x 254 x 35 | MW 1.65 | grey-blue |
| 216521803 | A4 | 312 x 222 x 100 | 324 x 241 x 106 | MW 1.65 | grey-blue |
| 214701503 | A4 | 312 x 222 x 100 | 324 x 241 x 106 | MW 1.7 | grey-blue |
| 2117203 | 24 x 30 | 313 x 260 x 60 | 328 x 274 x 65 | MW 1.6 | light grey |
| 216512503 | 24 x 30 | 313 x 260 x 60 | 328 x 274 x 65 | MW 1.65 | grey-blue |
| 216520303 | | 315 x 290 x 55 | 326 x 308 x 61 | MW 1.65 | grey-blue |
| 2117303 | | 315 x 290 x 55 | 326 x 308 x 61 | MW 1.7 | grey-blue |
| 2121003 | A4 | 320 x 232 x 60 | 328 x 246 x 65 | MW 1.6 | light grey |
| 216513303 | A4 | 320 x 232 x 60 | 328 x 246 x 65 | MW 1.65 | grey-blue |
| 2480403 | A4 | 320 x 232 x 60 | 332 x 252 x 67 | MW 1.7 | grey-blue |
| 216524903 | | 320 x 232 x 90 | 332 x 252 x 96 | MW 1.65 | grey-blue |

MW = corrugated board E-flute ; FW = corrugated board B-flute ; H = height ; W = width ; T = thickness ; D = depth ; L = length

7. Boxes

7.2 Clamshell boxes

KS 3

| Item | For size (cm) | Int. dimensions H x W x T (mm) | Ext. dimensions H x W x T (mm) | Material (mm) | Colour (exterior) |
|-----------|---------------|-----------------------------------|-----------------------------------|------------------|----------------------|
| 24801503 | | 320 x 232 x 90 | 332 x 252 x 96 | MW 1.7 | grey-blue |
| 2117403 | 24 x 30 | 320 x 240 x 90 | 328 x 254 x 95 | MW 1.6 | light grey |
| 216512603 | 24 x 30 | 320 x 240 x 90 | 328 x 254 x 95 | MW 1.65 | grey-blue |
| 21105031 | | 320 x 250 x 75 | 328 x 264 x 80 | MW 1.6 | light grey |
| 216510803 | | 320 x 250 x 75 | 328 x 264 x 80 | MW 1.65 | grey-blue |
| 2117503 | | 331 x 255 x 45 | 340 x 270 x 50 | MW 1.6 | light grey |
| 216512703 | | 331 x 255 x 45 | 340 x 270 x 50 | MW 1.65 | grey-blue |
| 216523203 | | 335 x 245 x 135 | 347 x 264 x 142 | MW 1.65 | grey-blue |
| 2147133 | | 335 x 245 x 135 | 347 x 264 x 142 | MW 1.7 | grey-blue |
| 216525003 | | 335 x 320 x 55 | 343 x 334 x 60 | MW 1.65 | grey-blue |
| 2480603 | | 335 x 320 x 55 | 343 x 334 x 60 | MW 1.7 | grey-blue |
| 3117603 | | 337 x 265 x 80 | 352 x 291 x 89 | FW 3.0 | light grey |
| 2117703 | | 340 x 227 x 75 | 351 x 245 x 81 | MW 1.6 | light grey |
| 216512903 | | 340 x 227 x 75 | 351 x 245 x 81 | MW 1.65 | grey-blue |
| 2110703 | | 345 x 255 x 65 | 353 x 269 x 70 | MW 1.6 | light grey |
| 216510903 | | 345 x 255 x 65 | 353 x 269 x 70 | MW 1.65 | grey-blue |
| 216520503 | | 350 x 220 x 80 | 362 x 240 x 87 | MW 1.65 | light grey |
| 2117903 | | 350 x 220 x 80 | 362 x 240 x 87 | MW 1.7 | grey-blue |
| 3110803 | folio | 350 x 235 x 60 | 367 x 262 x 69 | FW 3.0 | light grey |
| 3122003 | folio | 350 x 250 x 100 | 365 x 276 x 109 | FW 3.0 | light grey |
| 2122103 | folio | 350 x 270 x 70 | 358 x 284 x 75 | MW 1.6 | light grey |
| 216513403 | folio | 350 x 270 x 70 | 358 x 284 x 75 | MW 1.65 | grey-blue |
| 3122203 | folio | 355 x 255 x 100 | 374 x 285 x 110 | FW 3.1 | light grey |
| 3480903 | folio | 355 x 255 x 50 | 373 x 285 x 60 | FW 3.1 | grey-blue |
| 216524603 | | 358 x 261 x 63 | 370 x 280 x 70 | MW 1.65 | grey-blue |
| 2147803 | | 358 x 261 x 63 | 370 x 280 x 70 | MW 1.7 | grey-blue |
| 2111003 | | 360 x 250 x 35 | 368 x 264 x 40 | MW 1.6 | light grey |

MW = corrugated board E-flute ; FW = corrugated board B-flute ; H = height ; W = width ; T = thickness ; D = depth ; L = length

7. Boxes

7.2 Clamshell boxes

KS 3

| Item | For size (cm) | Int. dimensions H x W x T (mm) | Ext. dimensions H x W x T (mm) | Material (mm) | Colour (exterior) |
|-----------|---------------|-----------------------------------|-----------------------------------|------------------|----------------------|
| 216511003 | | 360 x 250 x 35 | 368 x 264 x 40 | MW 1.65 | grey-blue |
| 216521203 | | 360 x 260 x 170 | 372 x 279 x 177 | MW 1.65 | grey-blue |
| 214700340 | | 360 x 260 x 170 | 372 x 279 x 177 | MW 1.7 | grey-blue |
| 216520403 | | 360 x 270 x 70 | 372 x 289 x 76 | MW 1.65 | grey-blue |
| 2117803 | | 360 x 270 x 70 | 372 x 289 x 76 | MW 1.7 | grey-blue |
| 216521103 | | 360 x 270 x 90 | 372 x 289 x 96 | MW 1.65 | grey-blue |
| 214700333 | | 360 x 270 x 90 | 372 x 289 x 96 | MW 1.7 | grey-blue |
| 216520903 | | 360 x 270 x 100 | 371 x 288 x 106 | MW 1.65 | grey-blue |
| 214700331 | | 360 x 270 x 100 | 371 x 288 x 106 | MW 1.7 | grey-blue |
| 216523103 | | 365 x 270 x 60 | 377 x 289 x 67 | MW 1.65 | grey-blue |
| 2147063 | | 365 x 270 x 60 | 377 x 289 x 67 | MW 1.7 | grey-blue |
| 216524703 | | 380 x 260 x 113 | 392 x 279 x 120 | MW 1.65 | grey-blue |
| 2147903 | | 380 x 260 x 113 | 392 x 279 x 120 | MW 1.7 | grey-blue |
| 2123003 | large folio | 382 x 266 x 94 | 390 x 280 x 99 | MW 1.6 | light grey |
| 216513503 | large folio | 382 x 266 x 94 | 390 x 280 x 99 | MW 1.65 | grey-blue |
| 3123103 | | 393 x 291 x 69 | 410 x 320 x 79 | FW 3.0 | light grey |
| 216520603 | | 398 x 267 x 162 | 406 x 281 x 167 | MW 1.65 | grey-blue |
| 2123203 | | 398 x 267 x 162 | 406 x 281 x 167 | MW 1.7 | grey-blue |
| 3118003 | 30 x 40 | 414 x 313 x 60 | 429 x 339 x 69 | FW 3.0 | light grey |
| 2118103 | 30 x 40 | 415 x 310 x 50 | 423 x 324 x 55 | MW 1.6 | light grey |
| 216513003 | 30 x 40 | 415 x 310 x 50 | 423 x 324 x 55 | MW 1.65 | grey-blue |
| 2118203 | 30 x 40 | 425 x 302 x 60 | 433 x 316 x 65 | MW 1.6 | light grey |
| 216513103 | 30 x 40 | 425 x 302 x 60 | 433 x 316 x 65 | MW 1.65 | grey-blue |
| 216522103 | A3 | 427 x 312 x 60 | 439 x 331 x 66 | MW 1.65 | grey-blue |
| 214701603 | A3 | 427 x 312 x 60 | 439 x 331 x 66 | MW 1.7 | grey-blue |
| 216522203 | A3 | 427 x 322 x 60 | 439 x 341 x 66 | MW 1.65 | grey-blue |
| 214701803 | A3 | 427 x 322 x 60 | 439 x 341 x 66 | MW 1.7 | grey-blue |

MW = corrugated board E-flute ; FW = corrugated board B-flute ; H = height ; W = width ; T = thickness ; D = depth ; L = length

7. Boxes

7.2 Clamshell boxes

KS 3

| Item | For size (cm) | Int. dimensions H x W x T (mm) | Ext. dimensions H x W x T (mm) | Material (mm) | Colour (exterior) |
|-----------|---------------|--------------------------------|--------------------------------|---------------|-------------------|
| 3118303 | A3 | 440 x 330 x 70 | 455 x 356 x 79 | FW 3.0 | light grey |
| 2111203 | A3 | 440 x 340 x 35 | 448 x 354 x 40 | MW 1.6 | light grey |
| 216511103 | A3 | 440 x 340 x 35 | 448 x 354 x 40 | MW 1.65 | grey-blue |
| 3118403 | 40 x 50 | 500 x 400 x 80 | 515 x 426 x 89 | FW 3.0 | light grey |
| 3111303 | 35 x 50 | 505 x 355 x 60 | 518 x 381 x 69 | FW 3.0 | light grey |
| 3124003 | | 508 x 346 x 86 | 520 x 370 x 96 | FW 3.0 | light grey |
| 2147303 | | 510 x 454 x 82 | 522 x 473 x 89 | MW 1.7 | grey-blue |
| 3125003 | 40 x 50 | 516 x 414 x 60 | 531 x 440 x 69 | FW 3.0 | light grey |
| 2147033 | | 520 x 418 x 57 | 532 x 437 x 64 | MW 1.7 | grey-blue |
| 214700332 | | 550 x 370 x 90 | 562 x 389 x 96 | MW 1.7 | grey-blue |
| 3126003 | 50 x 60 | 619 x 516 x 60 | 639 x 542 x 69 | FW 3.0 | light grey |
| 2147023 | | 660 x 510 x 57 | 672 x 529 x 64 | MW 1.7 | grey-blue |
| 3127003 | 50 x 70 | 705 x 505 x 60 | 721 x 533 x 70 | FW 3.0 | light grey |
| 3128003 | 60 x 70 | 720 x 619 x 60 | 735 x 645 x 69 | FW 3.0 | light grey |
| 3129003 | 60 x 80 | 822 x 619 x 60 | 837 x 645 x 69 | FW 3.0 | light grey |
| | | | | | |
| | | | | | |
| | | | | | |
| | | | | | |
| | | | | | |
| | | | | | |
| | | | | | |
| | | | | | |
| | | | | | |
| | | | | | |
| | | | | | |
| | | | | | |
| | | | | | |
| | | | | | |
| | | | | | |
| | | | | | |
| | | | | | |
| | | | | | |

MW = corrugated board E-flute ; FW = corrugated board B-flute ; H = height ; W = width ; T = thickness ; D = depth ; L = length

7. Boxes

7.2 Clamshell boxes

KS 3 with textile fastening ribbons



A KS 3 tightly closing clamshell box with textile (polyester) fastening ribbons. The ribbons can be attached individually. The box is made from corrugated board material, MW 1.7, 680 gsm, exterior box colour grey-blue/interior colour natural white. Ideal for the archival storage of books, files/folders, documents and two-dimensional objects.

Other box sizes on request.

| Item | For size (cm) | Int. dimensions H x W x T (mm) | Ext. dimensions H x W x T (mm) | Material (mm) | Colour (exterior) |
|-------------|---------------|--------------------------------|--------------------------------|---------------|-------------------|
| 216521303 | landscape | 240 x 330 x 60 | 252 x 349 x 66 | MW 1.65 | grey-blue |
| 2147011003 | landscape | 240 x 330 x 60 | 252 x 349 x 66 | MW 1.7 | grey-blue |
| 216521403 | landscape | 270 x 380 x 60 | 282 x 399 x 66 | MW 1.65 | grey-blue |
| 2147012003 | landscape | 270 x 380 x 60 | 282 x 399 x 66 | MW 1.7 | grey-blue |
| 216521503 | landscape | 270 x 380 x 80 | 282 x 399 x 86 | MW 1.65 | grey-blue |
| 2147013003 | landscape | 270 x 380 x 80 | 282 x 399 x 86 | MW 1.7 | grey-blue |
| 216521603 | landscape | 270 x 380 x 120 | 282 x 399 x 126 | MW 1.65 | grey-blue |
| 2147014003 | landscape | 270 x 380 x 120 | 282 x 399 x 126 | MW 1.7 | grey-blue |
| 216522003 | portrait | 410 x 280 x 80 | 422 x 299 x 86 | MW 1.65 | grey-blue |
| 21470152003 | portrait | 410 x 280 x 80 | 422 x 299 x 86 | MW 1.7 | grey-blue |
| 216521903 | portrait, A3 | 430 x 320 x 80 | 442 x 339 x 86 | MW 1.65 | grey-blue |
| 21470151003 | portrait, A3 | 430 x 320 x 80 | 442 x 339 x 86 | MW 1.7 | grey-blue |
| 2147026003 | portrait | 450 x 380 x 60 | 462 x 399 x 66 | MW 1.7 | grey-blue |
| 2147021003 | portrait | 470 x 320 x 80 | 482 x 339 x 86 | MW 1.7 | grey-blue |
| 2147025003 | portrait | 500 x 450 x 60 | 512 x 469 x 66 | MW 1.7 | grey-blue |

MW = corrugated board E-flute ; FW = corrugated board B-flute ; H = height ; W = width ; T = thickness ; D = depth ; L = length

7. Boxes

7.2 Clamshell boxes

KS 3 with filing mechanism

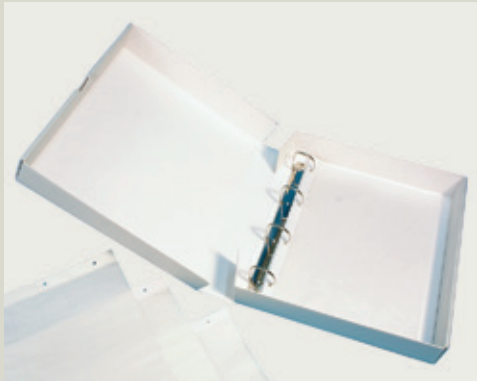

A reasonably priced, tightly closing clamshell box with binding mechanism. Suitable for filing 4-hole, pre-punched envelope enclosures, documents and photographic board in sheet form.

| Item | Design | Int. dimensions H x W x T (mm) | Ext. dimensions H x W x T (mm) | Material (mm) | Colour (exterior) |
|----------|-----------------------|-----------------------------------|-----------------------------------|------------------|----------------------|
| 652899 | with filing mechanism | 315 x 290 x 55 | 326 x 308 x 61 | MW 1.8 | light grey |
| 65289947 | with filing mechanism | 315 x 290 x 55 | 326 x 308 x 61 | MW 1.7 | grey-blue |
| 652900 | with filing mechanism | 335 x 320 x 55 | 343 x 334 x 60 | MW 1.8 | light grey |
| 65290047 | with filing mechanism | 335 x 320 x 55 | 343 x 334 x 60 | MW 1.7 | grey-blue |
| | | | | | |
| | | | | | |
| | | | | | |

7.2 Clamshell boxes

KS 4



A tightly closing and finely constructed clamshell box especially designed for books and unbound loose objects. A complete foldable construction, with completely smooth interior and exterior surfaces. Produced from board materials with weights ranging from approximately 330 to 900 gsm.

| Item | Design | Int. dimensions H x W x T (mm) | Ext. dimensions H x W x T (mm) | Material (mm) | Colour (exterior) |
|------|--------------|-----------------------------------|-----------------------------------|------------------|----------------------|
| | upon request | | | | |
| | | | | | |
| | | | | | |
| | | | | | |
| | | | | | |

MW = corrugated board E-flute ; FW = corrugated board B-flute ; H = height ; W = width ; T = thickness ; D = depth ; L = length

7. Boxes

7.2 Clamshell boxes

KS 17



A tightly closing clamshell box for books, photographs, loose and unbound objects. Closed, the box has a roundabout, four-fold walled construction for additional strength. Delivery with or without slits for flap inserts. Also available with an additional base support.

| Item | For size (cm) | Int. dimensions H x W x T (mm) | Ext. dimensions H x W x T (mm) | Material (mm) | Colour (exterior) |
|-----------|---------------|--------------------------------|--------------------------------|---------------|-------------------|
| 2110017 | 10 x 15 | 150 x 110 x 30 | 167 x 125 x 34 | MW 1.6 | light grey |
| 216510117 | 10 x 15 | 150 x 110 x 30 | 167 x 125 x 34 | MW 1.65 | grey-blue |
| 2110317 | folio | 330 x 250 x 80 | 348 x 269 x 86 | MW 1.6 | light grey |
| 216510717 | folio | 330 x 250 x 80 | 348 x 269 x 86 | MW 1.65 | grey-blue |
| 2110217 | | 355 x 280 x 130 | 374 x 300 x 136 | MW 1.8 | light grey |
| 2110117 | A3 | 430 x 305 x 50 | 447 x 320 x 54 | MW 1.6 | light grey |
| 216510317 | A3 | 430 x 305 x 50 | 447 x 320 x 54 | MW 1.65 | grey-blue |
| 3110117 | A3 | 430 x 320 x 75 | 457 x 349 x 79 | FW 3.0 | light grey |
| | | | | | |
| | | | | | |
| | | | | | |
| | | | | | |
| | | | | | |
| | | | | | |
| | | | | | |
| | | | | | |
| | | | | | |
| | | | | | |
| | | | | | |
| | | | | | |
| | | | | | |
| | | | | | |
| | | | | | |
| | | | | | |
| | | | | | |

MW = corrugated board E-flute ; FW = corrugated board B-flute ; H = height ; W = width ; T = thickness ; D = depth ; L = length

7. Boxes

7.2 Clamshell boxes

KS 17 Trier



A tightly closing clamshell box with an extra stable roundabout six-fold walled construction for extremely heavy and valuable objects. Smooth interior and exterior surfaces. Already umpteen times in use for incunabulum and graphic collections. Available with or without ribbons. Delivery assembled and upright.

| Item | For size (cm) | Int. dimensions H x W x T (mm) | Ext. dimensions H x W x T (mm) | Material (mm) | Colour (exterior) |
|------------|---------------|--------------------------------|--------------------------------|---------------|-------------------|
| on request | | | | | |
| | | | | | |
| | | | | | |
| | | | | | |
| | | | | | |
| | | | | | |
| | | | | | |

7.2 Clamshell boxes

KS 17 heavy-duty

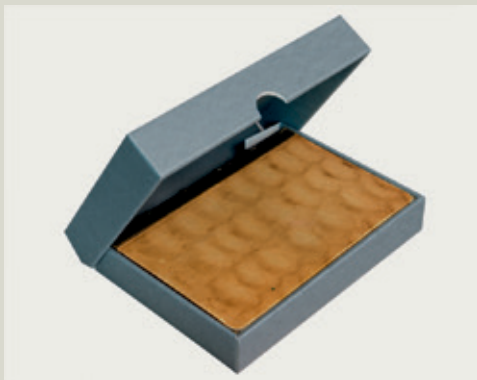

A sturdy and tightly closing clamshell box for books, photograph negatives/positives, glass plates and loosely bound objects. The box has a roundabout, four-fold walled construction and an additional base support for extra strength. Economical in price. Delivery without slits, assembled and upright.

| Item | For size (cm) | Int. dimensions H x W x T (mm) | Ext. dimensions H x W x T (mm) | Material (mm) | Colour (exterior) |
|-----------|---------------|--------------------------------|--------------------------------|---------------|-------------------|
| 216523717 | 13 x 18 | 184 x 134 x 60 | 203 x 154 x 70 | MW 1.65 | grey-blue |
| 21474017 | 13 x 18 | 184 x 134 x 60 | 203 x 154 x 70 | MW 1.7 | grey-blue |
| 216523817 | 13 x 18 | 205 x 150 x 60 | 224 x 170 x 70 | MW 1.65 | grey-blue |
| 2147417 | 13 x 18 | 205 x 150 x 60 | 224 x 170 x 70 | MW 1.7 | grey-blue |
| 216523917 | 18 x 24 | 244 x 184 x 60 | 263 x 170 x 70 | MW 1.65 | grey-blue |
| 21475017 | 18 x 24 | 244 x 184 x 60 | 263 x 170 x 70 | MW 1.7 | grey-blue |
| 216524017 | 18 x 24 | 255 x 195 x 50 | 274 x 215 x 60 | MW 1.65 | grey-blue |

MW = corrugated board E-flute ; FW = corrugated board B-flute ; H = height ; W = width ; T = thickness ; D = depth ; L = length

7. Boxes

7.2 Clamshell boxes

KS 17 heavy-duty

| Item | For size (cm) | Int. dimensions H x W x T (mm) | Ext. dimensions H x W x T (mm) | Material (mm) | Colour (exterior) |
|------------|---------------|--------------------------------|--------------------------------|---------------|-------------------|
| 2147517 | 18 x 24 | 255 x 195 x 50 | 274 x 215 x 60 | MW 1.7 | grey-blue |
| 216523517 | 18 x 24 | 255 x 195 x 60 | 274 x 215 x 70 | MW 1.65 | grey-blue |
| 21471917 | 18 x 24 | 255 x 195 x 60 | 274 x 215 x 70 | MW 1.7 | grey-blue |
| 216524117 | 24 x 30 | 304 x 244 x 60 | 323 x 264 x 70 | MW 1.65 | grey-blue |
| 21476117 | 24 x 30 | 304 x 244 x 60 | 323 x 264 x 70 | MW 1.7 | grey-blue |
| 216524217 | 24 x 30 | 315 x 255 x 40 | 334 x 274 x 50 | MW 1.65 | grey-blue |
| 2147617 | 24 x 30 | 315 x 255 x 40 | 334 x 274 x 50 | MW 1.7 | grey-blue |
| 216523317 | 24 x 30 | 315 x 255 x 60 | 334 x 274 x 70 | MW 1.65 | grey-blue |
| 21471717 | 24 x 30 | 315 x 255 x 60 | 334 x 274 x 70 | MW 1.7 | grey-blue |
| 216522417 | 27 x 33 | 355 x 280 x 130 | 374 x 299 x 140 | MW 1.65 | grey-blue |
| 21470217 | 27 x 33 | 355 x 280 x 130 | 374 x 299 x 140 | MW 1.7 | grey-blue |
| 216524517 | 30 x 40 | 403 x 304 x 50 | 423 x 324 x 60 | MW 1.65 | grey-blue |
| 21477417 | 30 x 40 | 403 x 304 x 50 | 423 x 324 x 60 | MW 1.7 | grey-blue |
| 216524417 | 30 x 40 | 415 x 315 x 30 | 434 x 334 x 40 | MW 1.65 | grey-blue |
| 2147717 | 30 x 40 | 415 x 315 x 30 | 434 x 334 x 40 | MW 1.7 | grey-blue |
| 216523417 | 30 x 40 | 415 x 315 x 60 | 434 x 334 x 70 | MW 1.65 | grey-blue |
| 21471817 | 30 x 40 | 415 x 315 x 60 | 434 x 334 x 70 | MW 1.7 | grey-blue |
| 21047417 | 40 x 50 | 504 x 404 x 30 | 523 x 424 x 40 | MW 1.7 | grey-blue |
| 2147021775 | 40 x 50 | 515 x 415 x 30 | 534 x 435 x 40 | MW 1.7 | grey-blue |
| 21047177 | 40 x 50 | 560 x 405 x 55 | 579 x 425 x 65 | MW 1.7 | grey-blue |
| 21476717 | 50 x 60 | 604 x 504 x 30 | 623 x 524 x 40 | MW 1.7 | grey-blue |
| 2147021776 | 50 x 60 | 615 x 515 x 30 | 634 x 535 x 40 | MW 1.7 | grey-blue |
| | | | | | |
| | | | | | |
| | | | | | |
| | | | | | |

MW = corrugated board E-flute ; FW = corrugated board B-flute ; H = height ; W = width ; T = thickness ; D = depth ; L = length

7. Boxes

7.2 Clamshell boxes

KS 17 Albertina

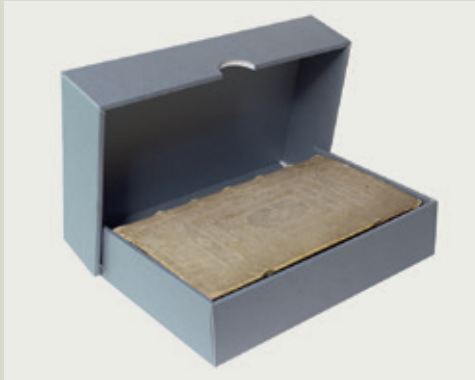

A tightly closing clamshell box with extra supports, ideal for graphic collections. Smooth interior and exterior surfaces. Round-about, eight-fold walled construction (closed condition of the box) for additional strength. Additional base and lid support is also provided. Even though absolutely dust-proof the box is still breathable.

Delivery assembled and upright.

| Item | Design | Int. dimensions H x W x T (mm) | Ext. dimensions H x W x T (mm) | Material (mm) | Colour (exterior) |
|-----------|--------|-----------------------------------|-----------------------------------|------------------|----------------------|
| 2101217 | | 503 x 353 x 70 | 544 x 384 x 81 | MW 1.7 | grey-blue |
| 2100117 | | 505 x 335 x 75 | 543 x 368 x 81 | MW 1.7 | grey-blue |
| 21202417 | | 520 x 420 x 50 | 560 x 445 x 61 | MW 1.7 | grey-blue |
| 2119017 | | 535 x 395 x 70 | 578 x 426 x 83 | MW 1.7 | grey-blue |
| 214737017 | | 580 x 445 x 65 | 620 x 470 x 76 | MW 1.7 | grey-blue |
| 2100317 | | 615 x 430 x 75 | 653 x 463 x 85 | MW 1.7 | grey-blue |
| 2101017 | | 615 x 500 x 50 | 653 x 533 x 61 | MW 1.7 | grey-blue |
| 210010172 | | 650 x 490 x 80 | 690 x 516 x 91 | MW 1.7 | grey-blue |
| 2101117 | | 660 x 510 x 80 | 701 x 541 x 89 | MW 1.7 | grey-blue |
| 2101517 | | 670 x 480 x 75 | 710 x 505 x 86 | MW 1.7 | grey-blue |
| 2101317 | | 703 x 503 x 70 | 744 x 534 x 81 | MW 1.7 | grey-blue |
| 21267217 | | 720 x 520 x 50 | 760 x 545 x 61 | MW 1.7 | grey-blue |
| 214737117 | | 770 x 585 x 65 | 810 x 610 x 76 | MW 1.7 | grey-blue |
| 2100517 | | 795 x 595 x 75 | 833 x 628 x 85 | MW 1.7 | grey-blue |
| 21267317 | | 820 x 620 x 50 | 860 x 628 x 85 | MW 1.7 | grey-blue |
| 2102117 | | 860 x 660 x 80 | 901 x 691 x 89 | MW 1.7 | grey-blue |
| 2100617 | | 1005 x 705 x 75 | 1043 x 738 x 85 | MW 1.7 | grey-blue |
| 2100917 | | 1140 x 775 x 75 | 1180 x 800 x 85 | MW 1.7 | grey-blue |
| | | | | | |
| | | | | | |
| | | | | | |
| | | | | | |
| | | | | | |
| | | | | | |
| | | | | | |
| | | | | | |
| | | | | | |

MW = corrugated board E-flute ; FW = corrugated board B-flute ; H = height ; W = width ; T = thickness ; D = depth ; L = length

7. Boxes

7.2 Clamshell boxes

KS18 Premium



A tightly closing premium clamshell box; a more elaborate version of the known „Solander Box“. Manufactured whilst using the finest book binding methods, this classical drop-back clamshell box is produced from solid conservation board with a complete fabric lining. Special emphasis has been given on ageing-resistant and environmentally compatible (less-polluting) materials. Delivery assembled and upright.

| Item | For format | Max. int. dimensions H x W x T (mm) | Max. height (mm) | Material (mm) |
|---------|------------|--|---------------------|-------------------------|
| 1920003 | portrait | 260 x 210 x 100 | max. 260 | conservation board, 2.0 |
| 1920004 | portrait | 350 x 260 x 100 | max. 350 | conservation board, 2.0 |
| 1920005 | portrait | 450 x 330 x 90 | max. 450 | conservation board, 2.0 |
| 1920007 | portrait | 500 x 350 x 90 | max. 500 | conservation board, 2.0 |
| 1920009 | portrait | 600 x 430 x 80 | max. 600 | conservation board, 2.0 |
| 1920012 | portrait | 700 x 500 x 80 | max. 700 | conservation board, 2.0 |
| 1920013 | portrait | 800 x 600 x 80 | max. 800 | conservation board, 2.0 |

7. Boxes

7.3 Slipcases

KS 5



A classical slipcase designed for books. Book spine visible. Available with or without a finger hole. Delivered either as a foldable construction with self-locking tabs (plug-in) or a pre-assembled construction, glued together. The former is shipped flat and the latter assembled and upright.

| Item | Design | Int. dimensions H x W x T (mm) | Ext. dimensions H x W x T (mm) | Material (mm) | Colour (exterior) |
|-----------|--|-----------------------------------|-----------------------------------|------------------|----------------------|
| 2110105 | glued, without finger hole | 278 x 120 x 40 | 283 x 125 x 48 | MW 1.6 | light grey |
| 216510105 | glued, without finger hole | 278 x 120 x 40 | 283 x 125 x 48 | MW 1.65 | grey-blue |
| 2110205 | glued, with finger hole | 300 x 209 x 73 | 305 x 214 x 81 | MW 1.6 | light grey |
| 216510205 | glued, with finger hole | 300 x 209 x 73 | 305 x 214 x 81 | MW 1.65 | grey-blue |
| 216520105 | glued, with finger hole | 316 x 226 x 85 | 321 x 231 x 93 | MW 1.65 | grey-blue |
| 2480305 | glued, with finger hole | 316 x 226 x 85 | 321 x 231 x 93 | MW 1.7 | grey-blue |
| 2110305 | self-locking tabs, without finger hole | 320 x 265 x 40 | 325 x 270 x 48 | MW 1.6 | light grey |
| 216510305 | self-locking tabs, without finger hole | 320 x 265 x 40 | 325 x 270 x 48 | MW 1.65 | grey-blue |
| 2110505 | glued, without finger hole | 365 x 220 x 20 | 370 x 225 x 28 | MW 1.6 | light grey |
| 216510405 | glued, without finger hole | 365 x 220 x 20 | 370 x 225 x 28 | MW 1.65 | grey-blue |
| 2110605 | glued, without finger hole | 365 x 220 x 30 | 370 x 225 x 38 | MW 1.6 | light grey |
| 216510505 | glued, without finger hole | 365 x 220 x 30 | 370 x 225 x 38 | MW 1.65 | grey-blue |
| 2110705 | glued, without finger hole | 365 x 220 x 40 | 370 x 225 x 48 | MW 1.6 | light grey |
| 216510605 | glued, without finger hole | 365 x 220 x 40 | 370 x 225 x 48 | MW 1.65 | grey-blue |
| | | | | | |
| | | | | | |
| | | | | | |
| | | | | | |
| | | | | | |
| | | | | | |
| | | | | | |
| | | | | | |
| | | | | | |
| | | | | | |
| | | | | | |
| | | | | | |
| | | | | | |

7. Boxes

7.4 Slipcases with shelf file

KS 6



A tightly closing slipcase with shelf file, designed for storing and organizing books, brochures, magazines, newspapers and loose-leaf collections (unbound documents). It can be put on a shelf just as a placeholder to ensure that objects are shelved tightly. Also available with an additional (standing) support for loose-leaf collections. For books it can also be used as a book shoe.

| Item | Design | Int. dimensions H x W x T (mm) | Ext. dimensions H x W x T (mm) | Material (mm) | Colour (exterior) |
|--------------|--------|-----------------------------------|-----------------------------------|------------------|----------------------|
| upon request | | | | | |
| | | | | | |
| | | | | | |
| | | | | | |
| | | | | | |
| | | | | | |

7. Boxes

7.5 Shelf files

KS 9



Shelf files designed for storing books, newspapers, brochures, magazines and collections of loose and unbound documents. Also available with an additional (standing) support mechanism to ensure that the filed objects are kept upright, thus preventing them from bending over if the shelf file is not full to capacity. For books it can also be used as a book shoe.

| Item | Design | Int. dimensions H x W x T (mm) | Ext. dimensions H x W x T (mm) | Material (mm) | Colour (exterior) |
|-----------|---------------------|-----------------------------------|-----------------------------------|------------------|----------------------|
| 2119009 | without finger hole | 250 x 200 x 80 | 259 x 206 x 85 | MW 1.6 | light grey |
| 216510109 | without finger hole | 250 x 200 x 80 | 259 x 206 x 85 | MW 1.65 | grey-blue |
| 2119109 | without finger hole | 265 x 220 x 50 | 274 x 226 x 55 | MW 1.6 | light grey |
| 216510209 | without finger hole | 265 x 220 x 50 | 274 x 226 x 55 | MW 1.65 | grey-blue |
| 216520109 | with finger hole | 300 x 230 x 80 | 309 x 239 x 86 | MW 1.65 | grey-blue |
| 214711009 | with finger hole | 300 x 230 x 80 | 309 x 239 x 86 | MW 1.7 | grey-blue |
| 216520309 | with finger hole | 307 x 220 x 80 | 316 x 226 x 85 | MW 1.65 | grey-blue |
| 2480109 | with finger hole | 307 x 220 x 80 | 316 x 226 x 85 | MW 1.7 | grey-blue |
| 216520209 | without finger hole | 320 x 270 x 80 | 329 x 279 x 86 | MW 1.65 | grey-blue |
| 214712009 | without finger hole | 320 x 270 x 80 | 329 x 279 x 86 | MW 1.7 | grey-blue |
| | | | | | |
| | | | | | |
| | | | | | |
| | | | | | |
| | | | | | |
| | | | | | |
| | | | | | |
| | | | | | |
| | | | | | |
| | | | | | |
| | | | | | |
| | | | | | |
| | | | | | |
| | | | | | |
| | | | | | |
| | | | | | |
| | | | | | |
| | | | | | |
| | | | | | |
| | | | | | |
| | | | | | |
| | | | | | |
| | | | | | |
| | | | | | |
| | | | | | |
| | | | | | |
| | | | | | |
| | | | | | |

MW = corrugated board E-flute ; FW = corrugated board B-flute ; H = height ; W = width ; T = thickness ; D = depth ; L = length

7. Boxes

7.6 Archival boxes

KS 7



An archival box made of two parts, the corpus box with drop-front including a slide-in base tray (can be pulled out) with attached flap. Ideal for the storage of expansion folders, unbound and loose-leaf collections and newspapers. For storage purposes the boxes can be stacked horizontally, one upon each other. Also available as a drop-front single piece with an attached flap.

| Item | For size design | Int. dimensions D x W x H (mm) | Ext. dimensions D x W x H (mm) | Material (mm) | Colour (exterior) |
|-----------|---------------------------|-----------------------------------|-----------------------------------|------------------|----------------------|
| 2110107 | with slide-in | 177 x 238 x 53 | 189 x 243 x 62 | MW 1.6 | light grey |
| 216510107 | with slide-in | 177 x 238 x 53 | 189 x 243 x 62 | MW 1.65 | grey-blue |
| 2130007 | A5 with slide-in | 210 x 148 x 85 | 215 x 160 x 94 | MW 1.6 | light grey |
| 216512207 | A5 with slide-in | 210 x 148 x 85 | 215 x 160 x 94 | MW 1.65 | grey-blue |
| 2110207 | with slide-in | 237 x 318 x 103 | 249 x 323 x 112 | MW 1.6 | light grey |
| 216510407 | with slide-in | 237 x 318 x 103 | 249 x 323 x 112 | MW 1.65 | grey-blue |
| 2110307 | with slide-in | 237 x 338 x 103 | 249 x 343 x 112 | MW 1.6 | light grey |
| 216510607 | with slide-in | 237 x 338 x 103 | 249 x 343 x 112 | MW 1.65 | grey-blue |
| 3130107 | with slide-in | 320 x 250 x 85 | 329 x 273 x 102 | FW 3.0 | light grey |
| 3130207 | with attached flap | 323 x 232 x 72 | 332 x 255 x 89 | FW 3.0 | light grey |
| 0355 | A4/folio with slide-in | 350 x 240 x 80 | 361 x 264 x 94 | FW 3.1 | light grey |
| 3121007 | A4/folio with slide-in | 360 x 240 x 105 | 369 x 263 x 122 | FW 3.0 | light grey |
| 3122007 | folio with slide-in | 380 x 250 x 100 | 289 x 273 x 117 | FW 3.0 | light grey |
| 3122107 | folio with slide-in | 385 x 259 x 95 | 390 x 280 x 110 | FW 3.0 | light grey |
| 3123007 | large folio with slide-in | 390 x 270 x 105 | 399 x 293 x 122 | FW 3.0 | light grey |
| 3123107 | with slide-in | 390 x 280 x 110 | 399 x 303 x 127 | FW 3.0 | light grey |
| 3123207 | with slide-in | 390 x 280 x 115 | 399 x 303 x 132 | FW 3.0 | light grey |
| 3123307 | with attached flap | 390 x 270 x 230 | 399 x 293 x 247 | FW 3.0 | light grey |
| 3123407 | large folio with slide-in | 400 x 280 x 120 | 409 x 303 x 137 | FW 3.0 | light grey |
| | | | | | |
| | | | | | |
| | | | | | |
| | | | | | |
| | | | | | |
| | | | | | |
| | | | | | |
| | | | | | |
| | | | | | |

MW = corrugated board E-flute ; FW = corrugated board B-flute ; H = height ; W = width ; T = thickness ; D = depth ; L = length

7. Boxes

7.6 Archival boxes

KS 13

A clamshell type storage box with roundabout, double-walled construction for additional strength. Smooth interior surfaces. Also available with drop-front on the long side and with box partitions. Suitable for the storage of microfiches, postcards and film negatives.



| Item | For size (cm) | Int. dimensions D x W x H (mm) | Ext. dimensions D x W x H (mm) | Material (mm) | Colour (exterior) |
|-----------|---|-----------------------------------|-----------------------------------|------------------|----------------------|
| 2113013 | 11.5 x 11 | 115 x 110 x 35 | 125 x 117 x 40 | MW 1.6 | light grey |
| 216511113 | 11.5 x 11 | 115 x 110 x 35 | 125 x 117 x 40 | MW 1.65 | grey-blue |
| 2115013 | 18 x 24 | 240 x 180 x 35 | 250 x 187 x 40 | MW 1.6 | light grey |
| 216511313 | 18 x 24 | 240 x 180 x 35 | 250 x 187 x 40 | MW 1.65 | grey-blue |
| 2110213 | 4 compartment for total 500 microfiches | 326 x 318 x 110 | 336 x 332 x 115 | MW 1.6 | light grey |
| 216510513 | 4 compartment for total 500 microfiches | 326 x 318 x 110 | 336 x 332 x 115 | MW 1.65 | grey-blue |

MW = corrugated board E-flute ; FW = corrugated board B-flute ; H = height ; W = width ; T = thickness ; D = depth ; L = length

7. Boxes

7.6 Archival boxes

KS 14



An archival box for the upright storage of expansion folders, glass plates, collections with loose and unbound objects, brochures and magazines. Smooth interior surfaces.

Upon request available with a finger hole, with upright supports and with a flap on the front side.

| Item | For size (cm) design | Int. dimensions H x W x T (mm) | Ext. dimensions H x W x T (mm) | Material (mm) | Colour (exterior) |
|------------|----------------------------------|--------------------------------|--------------------------------|---------------|-------------------|
| 651214 | 9 x 13, for 4-flap enclosures | 95 x 135 x 105 | 101 x 145 x 111 | MW 1.6 | light grey |
| 216512814 | 9 x 13, for 4-flap enclosures | 95 x 135 x 105 | 101 x 145 x 111 | MW 1.65 | grey-blue |
| 651114 | 9 x 12, for 4-flap enclosures | 98 x 128 x 105 | 104 x 138 x 111 | MW 1.6 | light grey |
| 216512714 | 9 x 12, for 4-flap enclosures | 98 x 128 x 105 | 104 x 138 x 111 | MW 1.65 | grey-blue |
| 651314 | 10 x 15, for 4-flap enclosures | 105 x 155 x 105 | 111 x 165 x 111 | MW 1.6 | light grey |
| 216513014 | 10 x 15, for 4-flap enclosures | 105 x 155 x 105 | 111 x 165 x 111 | MW 1.65 | grey-blue |
| 6512141 | 9 x 13, for envelope enclosures | 115 x 138 x 105 | 121 x 148 x 111 | MW 1.6 | light grey |
| 216512914 | 9 x 13, for envelope enclosures | 115 x 138 x 105 | 121 x 148 x 111 | MW 1.65 | grey-blue |
| 6513141 | 10 x 15, for envelope enclosures | 125 x 158 x 105 | 131 x 168 x 111 | MW 1.6 | light grey |
| 216513114 | 10 x 15, for envelope enclosures | 125 x 158 x 105 | 131 x 168 x 111 | MW 1.65 | grey-blue |
| 651514 | 13 x 18, for 4-flap enclosures | 135 x 185 x 105 | 141 x 195 x 111 | MW 1.6 | light grey |
| 216513214 | 13 x 18, for 4-flap enclosures | 135 x 185 x 105 | 141 x 195 x 111 | MW 1.65 | grey-blue |
| 6515141 | 13 x 18, for envelope enclosures | 155 x 193 x 105 | 161 x 203 x 111 | MW 1.6 | light grey |
| 216513314 | 13 x 18, for envelope enclosures | 155 x 193 x 105 | 161 x 203 x 111 | MW 1.65 | grey-blue |
| 2110114 | | 169 x 243 x 53 | 178 x 249 x 59 | MW 1.6 | light grey |
| 216510214 | | 169 x 243 x 53 | 178 x 249 x 59 | MW 1.65 | grey-blue |
| 651614 | 18 x 24, for 4-flap enclosures | 185 x 260 x 105 | 191 x 270 x 111 | MW 1.6 | light grey |
| 216513414 | 18 x 24, for 4-flap enclosures | 185 x 260 x 105 | 191 x 270 x 111 | MW 1.65 | grey-blue |
| 6516141 | 18 x 24, for envelope enclosures | 202 x 253 x 105 | 208 x 263 x 111 | MW 1.6 | light grey |
| 216513514 | 18 x 24, for envelope enclosures | 202 x 253 x 105 | 208 x 263 x 111 | MW 1.65 | grey-blue |
| 216520614 | | 223 x 290 x 80 | 236 x 305 x 87 | MW 1.65 | grey-blue |
| 2147080014 | | 223 x 290 x 80 | 236 x 305 x 87 | MW 1.7 | grey-blue |
| 216520714 | | 223 x 290 x 100 | 236 x 305 x 107 | MW 1.65 | grey-blue |
| 2147081014 | | 223 x 290 x 100 | 236 x 305 x 107 | MW 1.7 | grey-blue |
| 216520814 | | 223 x 290 x 120 | 236 x 305 x 127 | MW 1.65 | grey-blue |
| 2147082014 | | 223 x 290 x 120 | 236 x 305 x 127 | MW 1.7 | grey-blue |
| 3121014 | A4, folio | 240 x 360 x 105 | 251 x 377 x 114 | FW 3.0 | light grey |

MW = corrugated board E-flute ; FW = corrugated board B-flute ; H = height ; W = width ; T = thickness ; D = depth ; L = length

7. Boxes

7.6 Archival boxes

KS 14

| Item | For size (cm) design | Int. dimensions H x W x T (mm) | Ext. dimensions H x W x T (mm) | Material (mm) | Colour (exterior) |
|------------|----------------------------------|-----------------------------------|-----------------------------------|------------------|----------------------|
| 651714 | 24 x 30, for 4-flap enclosures | 245 x 305 x 105 | 251 x 315 x 111 | MW 1.6 | light grey |
| 216513614 | 24 x 30, for 4-flap enclosures | 245 x 305 x 105 | 251 x 315 x 111 | MW 1.65 | grey-blue |
| 216520914 | | 250 x 320 x 50 | 263 x 335 x 57 | MW 1.65 | grey-blue |
| 2147083014 | | 250 x 320 x 50 | 263 x 335 x 57 | MW 1.7 | grey-blue |
| 216521014 | | 250 x 335 x 60 | 263 x 350 x 67 | MW 1.65 | grey-blue |
| 2147084014 | | 250 x 335 x 60 | 263 x 350 x 67 | MW 1.7 | grey-blue |
| 216521214 | A4 | 250 x 335 x 80 | 263 x 350 x 87 | MW 1.65 | grey-blue |
| 214709114 | A4 | 250 x 335 x 80 | 263 x 350 x 87 | MW 1.7 | grey-blue |
| 216521314 | A4 | 250 x 335 x 100 | 263 x 350 x 107 | MW 1.65 | grey-blue |
| 214709214 | A4 | 250 x 335 x 100 | 263 x 350 x 107 | MW 1.7 | grey-blue |
| 216521414 | A4 | 250 x 335 x 120 | 263 x 350 x 127 | MW 1.65 | grey-blue |
| 214709314 | A4 | 250 x 335 x 120 | 263 x 350 x 127 | MW 1.7 | grey-blue |
| 216521114 | | 250 x 335 x 140 | 263 x 350 x 147 | MW 1.65 | grey-blue |
| 2147085014 | | 250 x 335 x 140 | 263 x 350 x 147 | MW 1.7 | grey-blue |
| 2116114 | 18 x 24, for envelope enclosures | 260 x 195 x 105 | 270 x 201 x 111 | MW 1.6 | light grey |
| 216511614 | 18 x 24, for envelope enclosures | 260 x 195 x 105 | 270 x 201 x 111 | MW 1.65 | grey-blue |
| 6517141 | 24 x 30, for envelope enclosures | 267 x 313 x 105 | 273 x 323 x 111 | MW 1.6 | light grey |
| 216513714 | 24 x 30, for envelope enclosures | 267 x 313 x 105 | 273 x 323 x 111 | MW 1.65 | grey-blue |
| 216521514 | | 275 x 352 x 109 | 288 x 367 x 116 | MW 1.65 | grey-blue |
| 2147099814 | | 275 x 352 x 109 | 288 x 367 x 116 | MW 1.7 | grey-blue |
| 216520114 | 30 x 40, for 4-flap enclosures | 300 x 400 x 90 | 307 x 412 x 97 | MW 1.65 | grey-blue |
| 2118014 | 30 x 40, for 4-flap enclosures | 300 x 400 x 90 | 307 x 412 x 97 | MW 1.7 | grey-blue |
| 216520214 | 30 x 40, for 4-flap enclosures | 300 x 400 x 140 | 307 x 412 x 147 | MW 1.65 | grey-blue |
| 2118114 | 30 x 40, for 4-flap enclosures | 300 x 400 x 140 | 307 x 412 x 147 | MW 1.7 | grey-blue |
| 3117014 | | 302 x 370 x 162 | 313 x 387 x 173 | FW 3.0 | light grey |
| 651814 | 30 x 40, for envelope enclosures | 325 x 413 x 105 | 337 x 427 x 111 | MW 1.6 | light grey |
| 216513814 | 30 x 40, for envelope enclosures | 325 x 413 x 105 | 337 x 427 x 111 | MW 1.65 | grey-blue |

MW = corrugated board E-flute ; FW = corrugated board B-flute ; H = height ; W = width ; T = thickness ; D = depth ; L = length

7. Boxes

7.6 Archival boxes

KS 14 – for gramophone records



A double-walled archival storage box for the upright storage of vinyl gramophone records, LP 33, 45 and 78 min⁻¹. Made from corrugated board material MW 1.7, 680 gsm, exterior colour grey-blue, interior natural white, with smooth interior surfacae.

Delivery flat, on request assembled and upright.

| Item | For size design | Int. dimensions H x W x T (mm) | Ext. dimensions H x W x T (mm) | Material (mm) | Colour (exterior) |
|-----------|-------------------|-----------------------------------|-----------------------------------|------------------|----------------------|
| 216521714 | vinyl record 33 T | 330 x 330 x 152 | 341 x 345 x 165 | MW 1.65 | grey-blue |
| 21472014 | vinyl record 33 T | 330 x 330 x 152 | 341 x 345 x 165 | MW 1.7 | grey-blue |
| 216521614 | vinyl record 45 T | 190 x 197 x 229 | 201 x 213 x 242 | MW 1.65 | grey-blue |
| 21471914 | vinyl record 45 T | 190 x 197 x 229 | 201 x 213 x 242 | MW 1.7 | grey-blue |
| 216520514 | vinyl record 78 T | 280 x 280 x 100 | 291 x 296 x 113 | MW 1.65 | grey-blue |
| 21470144 | vinyl record 78 T | 280 x 280 x 100 | 291 x 296 x 113 | MW 1.7 | grey-blue |
| | | | | | |
| | | | | | |
| | | | | | |
| | | | | | |
| | | | | | |
| | | | | | |
| | | | | | |
| | | | | | |
| | | | | | |
| | | | | | |
| | | | | | |
| | | | | | |
| | | | | | |
| | | | | | |
| | | | | | |
| | | | | | |
| | | | | | |
| | | | | | |

MW = corrugated board E-flute ; FW = corrugated board B-flute ; H = height ; W = width ; T = thickness ; D = depth ; L = length

7. Boxes

7.6 Archival boxes

KS 15 – with compartments



Two-piece archival box, comprising a drop-front corpus and an inner pull-out box, for the vertical storage of postcards, prints and glass plates. The fixed dividers between the compartments keep the objects upright, even if the inner box is not completely filled. Stackable. The corpus acts as a placeholder on the shelf.

| Item | For size (cm) format | Number of compartments | Compartment size D x W x H (mm) | Box dimens. (ext.) D x W x H (mm) | Material (mm) | Colour (exterior) |
|-----------|----------------------|------------------------|---------------------------------|-----------------------------------|---------------|-------------------|
| 2190015 | 4.5 x 6.5 | 2 | 67 x 67 x 50 | 168 x 96 x 60 | MW 1.6 | light grey |
| 216512315 | 4.5 x 6.5 | 2 | 67 x 67 x 50 | 168 x 96 x 60 | MW 1.65 | grey-blue |
| 2190115 | 6 x 9 | 2 | 90 x 70 x 70 | 167 x 118 x 81 | MW 1.6 | light grey |
| 216512415 | 6 x 9 | 2 | 90 x 70 x 70 | 167 x 118 x 81 | MW 1.65 | grey-blue |
| 2112015 | 9 x 12, 9 x 13 | 4 | 75 x 142 x 150 | 336 x 172 x 162 | MW 1.6 | light grey |
| 216510915 | 9 x 12, 9 x 13 | 4 | 75 x 142 x 150 | 336 x 172 x 162 | MW 1.65 | grey-blue |
| 2190315 | 10 x 15 | 2 | 98 x 153 x 108 | 227 x 180 x 120 | MW 1.6 | light grey |
| 216512515 | 10 x 15 | 2 | 98 x 153 x 108 | 227 x 180 x 120 | MW 1.65 | grey-blue |
| 216520315 | 10 x 15 | 3 | 75 x 170 x 150 | 260 x 200 x 160 | MW 1.65 | grey-blue |
| 2118115 | 10 x 15 | 3 | 75 x 170 x 150 | 260 x 200 x 160 | MW 1.7 | grey-blue |
| 2115015 | 10 x 15, 13 x 18 | 4 | 75 x 195 x 150 | 336 x 225 x 162 | MW 1.6 | light grey |
| 216511415 | 10 x 15, 13 x 18 | 4 | 75 x 195 x 150 | 336 x 225 x 162 | MW 1.65 | grey-blue |
| 21102015 | 10 x 21 | 2 | 92 x 215 x 117 | 300 x 243 x 129 | MW 1.6 | light grey |
| 216510315 | 10 x 21 | 2 | 92 x 215 x 117 | 300 x 243 x 129 | MW 1.65 | grey-blue |
| 2119815 | 13 x 12 | 4 | 75 x 142 x 138 | 336 x 172 x 147 | MW 1.6 | light grey |
| 216512015 | 13 x 12 | 4 | 75 x 142 x 138 | 336 x 172 x 147 | MW 1.65 | grey-blue |
| 2190415 | 13 x 18, 12 x 16 | 2 | 108 x 183 x 140 | 248 x 210 x 150 | MW 1.6 | light grey |
| 216512615 | 13 x 18, 12 x 16 | 2 | 108 x 183 x 140 | 248 x 210 x 150 | MW 1.65 | grey-blue |
| 216520415 | 13 x 18 | 3 | 73 x 200 x 180 | 255 x 230 x 190 | MW 1.65 | grey-blue |
| 2118215 | 13 x 18 | 3 | 73 x 200 x 180 | 255 x 230 x 190 | MW 1.7 | grey-blue |
| 2118015 | 13 x 18 | 4 | 73 x 187 x 153 | 337 x 217 x 165 | MW 1.6 | light grey |
| 216511915 | 13 x 18 | 4 | 73 x 187 x 153 | 337 x 217 x 165 | MW 1.65 | grey-blue |
| 3115015 | 18 x 24 | 4 | 73 x 253 x 195 | 342 x 291 x 210 | FW 3.0 | light grey |
| 2147615 | 18 x 24 | 4 | 76 x 252 x 210 | 335 x 285 x 225 | MW 1.7 | grey-blue |
| | | | | | | |
| | | | | | | |
| | | | | | | |

MW = corrugated board E-flute ; FW = corrugated board B-flute ; H = height ; W = width ; T = thickness ; D = depth ; L = length

7. Boxes

7.6 Archival boxes

KS 15 – with slotted inlay

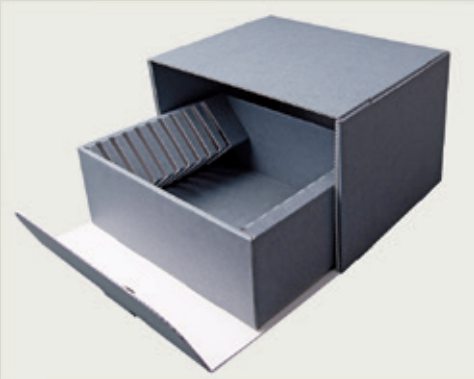

Two-piece archival box, comprising a drop-front corpus and an inner pull-out box, for the vertical and gentle storage of up to ten glass plates. The slotted inlay prevents pressure caused by plate-to-plate contact. Stackable. The corpus acts as a placeholder on the shelf.

| Item | For size (cm) format | Int. dimens. (inner box) D x W x H (mm) | Ext. box dimens. D x W x H (mm) | Material (mm) | Colour (exterior) |
|-----------|----------------------------------|---|---------------------------------|---------------|-------------------|
| 2111015 | 8.5 x 10.5 – for 10 glass plates | 162 x 114 x 92 | 177 x 150 x 107 | MW 1.6 | light grey |
| 216510715 | 8.5 x 10.5 – for 10 glass plates | 162 x 114 x 92 | 177 x 150 x 107 | MW 1.65 | grey-blue |
| 2111115 | 9 x 12 – for 10 glass plates | 160 x 122 x 95 | 177 x 160 x 110 | MW 1.6 | light grey |
| 216510815 | 9 x 12 – for 10 glass plates | 160 x 122 x 95 | 177 x 160 x 110 | MW 1.65 | grey-blue |
| 2112115 | 9 x 13 – for 10 glass plates | 160 x 132 x 95 | 177 x 170 x 110 | MW 1.6 | light grey |
| 216511015 | 9 x 13 – for 10 glass plates | 160 x 132 x 95 | 177 x 170 x 110 | MW 1.65 | grey-blue |
| 2113115 | 10 x 15 – for 10 glass plates | 160 x 155 x 105 | 177 x 195 x 115 | MW 1.6 | light grey |
| 216511215 | 10 x 15 – for 10 glass plates | 160 x 155 x 105 | 177 x 195 x 115 | MW 1.65 | grey-blue |
| 2115115 | 13 x 18 – for 10 glass plates | 160 x 185 x 135 | 177 x 226 x 145 | MW 1.6 | light grey |
| 216511515 | 13 x 18 – for 10 glass plates | 160 x 185 x 135 | 177 x 226 x 145 | MW 1.65 | grey-blue |
| 2116115 | 18 x 24 – for 10 glass plates | 160 x 243 x 190 | 177 x 285 x 200 | MW 1.6 | light grey |
| 216511715 | 18 x 24 – for 10 glass plates | 160 x 243 x 190 | 177 x 285 x 200 | MW 1.65 | grey-blue |
| 2117115 | 24 x 30 – for 10 glass plates | 160 x 305 x 245 | 181 x 351 x 265 | FW 3.0 | light grey |

MW = corrugated board E-flute ; FW = corrugated board B-flute ; H = height ; W = width ; T = thickness ; D = depth ; L = length

7. Boxes

7.7 Two-piece boxes

KS 8



A reasonably priced, two-piece storage box comprising a base and a lid. While closed the box is double-walled all around. Simple folding construction with self-locking tabs. Ideal for the storage of textiles, paintings, archival objects and collection items.

| Item | For size (cm) format | Int. dimensions L x W x H/H* (mm) | Ext. dimensions L x W x H (mm) | Material (mm) | Colour (exterior) |
|-----------|----------------------|-----------------------------------|--------------------------------|---------------|-------------------|
| 2111008 | 9 x 12 | 338 x 115 x 160/80 | 348 x 130 x 164 | MW 1.6 | light grey |
| 216510708 | 9 x 12 | 338 x 115 x 160/80 | 348 x 130 x 164 | MW 1.65 | grey-blue |
| 2115308 | 13 x 18 | 338 x 200 x 160/80 | 348 x 215 x 164 | MW 1.6 | light grey |
| 216511508 | 13 x 18 | 338 x 200 x 160/80 | 348 x 215 x 164 | MW 1.65 | grey-blue |
| 2115108 | 18 x 24 | 240 x 180 x 80/80 | 249 x 193 x 84 | MW 1.6 | light grey |
| 216511408 | 18 x 24 | 240 x 180 x 80/80 | 249 x 193 x 84 | MW 1.65 | grey-blue |
| 3115208 | 18 x 24 | 240 x 190 x 140/140 | 257 x 204 x 148 | FW 3.0 | light grey |
| 3116008 | 20 x 30 | 312 x 200 x 160/160 | 329 x 214 x 168 | FW 3.0 | light grey |
| 2116108 | 24 x 30 | 338 x 260 x 210/105 | 348 x 275 x 215 | MW 1.6 | light grey |
| 216511608 | 24 x 30 | 338 x 260 x 210/105 | 348 x 275 x 215 | MW 1.65 | grey-blue |
| 2117008 | 24 x 30 | 338 x 320 x 275/134 | 348 x 335 x 279 | MW 1.6 | light grey |
| 216511708 | 24 x 30 | 338 x 320 x 257/134 | 348 x 335 x 279 | MW 1.65 | grey-blue |
| 2117108 | | 340 x 256 x 105/105 | 349 x 269 x 109 | MW 1.6 | light grey |
| 216511808 | | 340 x 256 x 105/105 | 349 x 269 x 109 | MW 1.65 | grey-blue |
| 2117208 | | 340 x 265 x 80/80 | 357 x 289 x 88 | MW 1.6 | light grey |
| 216511908 | | 340 x 265 x 80/80 | 357 x 289 x 88 | MW 1.65 | grey-blue |
| 3117308 | | 373 x 261 x 142/142 | 390 x 285 x 150 | FW 3.0 | light grey |
| 3117408 | | 382 x 261 x 103/103 | 400 x 285 x 110 | FW 3.0 | light grey |
| 3117508 | | 390 x 280 x 110/110 | 407 x 304 x 118 | FW 3.0 | light grey |
| 3117608 | | 400 x 300 x 120/80 | 417 x 324 x 128 | FW 3.0 | light grey |
| 3117708 | | 540 x 383 x 104/104 | 559 x 409 x 112 | FW 3.0 | light grey |
| 3117808 | | 570 x 445 x 76/76 | 587 x 469 x 84 | FW 3.0 | light grey |
| 652008 | microfiches | 330 x 160 x 120/120 | 347 x 469 x 84 | MW 1.6 | light grey |
| 216512108 | microfiches | 330 x 160 x 120/120 | 347 x 469 x 84 | MW 1.65 | grey-blue |
| | | | | | |
| | | | | | |
| | | | | | |

MW = corrugated board E-flute ; FW = corrugated board B-flute ; H = height ; H* 2nd H dimension is the lid height ; W = width ; T = thickness ; D = depth ; L = length

7. Boxes

7.7 Two-piece boxes

KS 12



A two-piece storage box comprising a base and a lid, double-walled on four sides. While closed the box is four-walled all around and thus extremely sturdy. The folding construction ensures smooth interior surfaces. Upon request also available with a drop-front opening.

| Item | Design | Int. dimensions L x W x H/H* (mm) | Ext. dimensions L x W x H (mm) | Material (mm) | Colour (exterior) |
|-----------|-----------------------------------|--------------------------------------|-----------------------------------|------------------|----------------------|
| 2480112 | longer side with drop-front | 240 x 200 x 50/50 | 260 x 221 x 56 | MW 1.8 | light grey |
| 2131012 | drop-front on the longer side | 320 x 250 x 50/50 | 345 x 276 x 57 | MW 1.8 | light grey |
| 2132012 | drop-front on the longer side | 380 x 260 x 50/50 | 399 x 280 x 56 | MW 1.8 | light grey |
| 2132112 | drop-front on the longer side | 380 x 290 x 50/50 | 399 x 310 x 56 | MW 1.8 | light grey |
| 216520112 | lid and base unit with drop-front | 385 x 275 x 105/105 | 415 x 305 x 112 | MW 1.65 | grey-blue |
| 2110212 | lid and base unit with drop-front | 385 x 275 x 105/105 | 415 x 305 x 112 | MW 1.7 | grey-blue |
| 2110312 | drop-front on the longer side | 505 x 405 x 60/60 | 540 x 436 x 64 | MW 1.6 | light grey |
| 216510212 | drop-front on the longer side | 505 x 405 x 60/60 | 540 x 436 x 64 | MW 1.65 | grey-blue |
| 2133012 | without drop-front | 620 x 440 x 95/95 | 639 x 460 x 101 | MW 1.6 | light grey |
| 216512012 | without drop-front | 620 x 440 x 95/95 | 639 x 460 x 101 | MW 1.65 | grey-blue |
| | | | | | |
| | | | | | |
| | | | | | |
| | | | | | |
| | | | | | |
| | | | | | |
| | | | | | |
| | | | | | |
| | | | | | |
| | | | | | |
| | | | | | |
| | | | | | |
| | | | | | |
| | | | | | |
| | | | | | |
| | | | | | |
| | | | | | |
| | | | | | |

MW = corrugated board E-flute ; FW = corrugated board B-flute ; H = height ; H* 2nd H dimension is the lid height ; W = width ; T = thickness ; D = depth ; L = length

7. Boxes

7.7 Two-piece boxes

KS 16



A two-piece storage box, comprising of a base and a lid which are both double-walled on two sides. While closed the box is triple-walled all around and thus very sturdy. The folding construction ensures smooth interior surfaces.

Our most popular two-piece storage box, umpteen times in use. Ideal for the storage of large-sized objects, e.g. textiles, musical instruments, paintings, art objects etc..

On request the base unit can be provided with a drop-front opening.

| Item | For size (cm) design | Int. dimensions L x W x H/H* (mm) | Ext. dimensions L x W x H (mm) | Material (mm) | Colour (exterior) |
|-----------|-------------------------------|--------------------------------------|-----------------------------------|------------------|----------------------|
| 2110116 | | 135 x 135 x 127/63 | 152 x 152 x 133 | MW 1.6 | light grey |
| 216510116 | | 135 x 135 x 127/63 | 152 x 152 x 133 | MW 1.65 | grey-blue |
| 2480116 | without slits | 151 x 151 x 75/75 | 172 x 174 x 87 | MW 1.8 | light grey |
| 2111216 | | 270 x 106 x 105/50 | 288 x 123 x 111 | MW 1.6 | light grey |
| 216510916 | | 270 x 106 x 105/50 | 288 x 123 x 111 | MW 1.65 | grey-blue |
| 2112016 | 4 dividers (dimens. 27.3 x 9) | 273 x 150 x 95/40 | 294 x 172 x 102 | MW 1.6 | light grey |
| 216511316 | 4 dividers (dimens. 27.3 x 9) | 273 x 150 x 95/40 | 294 x 172 x 102 | MW 1.65 | grey-blue |
| 2110416 | | 298 x 225 x 170/60 | 317 x 246 x 177 | MW 1.8 | light grey |
| 2111116 | | 332 x 252 x 104/104 | 350 x 270 x 110 | MW 1.6 | light grey |
| 216510816 | | 332 x 252 x 104/104 | 350 x 270 x 110 | MW 1.65 | grey-blue |
| 2111316 | | 333 x 245 x 95/95 | 350 x 260 x 100 | MW 1.6 | light grey |
| 216511016 | | 333 x 245 x 95/95 | 350 x 260 x 100 | MW 1.65 | grey-blue |
| 2110516 | | 340 x 265 x 100/100 | 355 x 280 x 106 | MW 1.6 | light grey |
| 216510316 | | 340 x 265 x 100/100 | 355 x 280 x 106 | MW 1.65 | grey-blue |
| 2111416 | | 358 x 25 x 96/96 | 391 x 293 x 102 | FW 3.0 | light grey |
| 2110616 | | 362 x 252 x 104/104 | 380 x 270 x 110 | MW 1.6 | light grey |
| 216510416 | | 362 x 252 x 104/104 | 380 x 270 x 110 | MW 1.65 | grey-blue |
| 3110716 | | 370 x 243 x 85/85 | 395 x 270 x 90 | FW 3.0 | light grey |
| 2110816 | | 375 x 265 x 95/95 | 390 x 280 x 100 | MW 1.6 | light grey |
| 216510516 | | 375 x 265 x 95/95 | 390 x 280 x 100 | MW 1.65 | grey-blue |
| 2111516 | | 375 x 265 x 145/145 | 390 x 280 x 150 | MW 1.6 | light grey |
| 216511116 | | 375 x 265 x 145/145 | 390 x 280 x 150 | MW 1.65 | grey-blue |
| 2111616 | | 375 x 265 x 194/100 | 396 x 287 x 201 | MW 1.6 | light grey |
| 216511216 | | 375 x 265 x 194/100 | 396 x 287 x 201 | MW 1.65 | grey-blue |
| 2110016 | A4, folio (Brauweiler box) | 382 x 261 x 103/103 | 400 x 282 x 110 | MW 1.6 | light grey |
| 2110916 | | 382 x 272 x 104/104 | 400 x 290 x 110 | MW 1.6 | light grey |
| 216510616 | | 382 x 272 x 104/104 | 400 x 290 x 110 | MW 1.65 | grey-blue |

MW = corrugated board E-flute ; FW = corrugated board B-flute ; H = height ; H* 2nd H dimension is the lid height ; W = width ; T = thickness ; D = depth ; L = length

7. Boxes

7.7 Two-piece boxes

KS 16

| Item | For size (cm) design | Int. dimensions L x W x H/H* (mm) | Ext. dimensions L x W x H (mm) | Material (mm) | Colour (exterior) |
|-----------|-----------------------------|--------------------------------------|-----------------------------------|------------------|----------------------|
| 216520216 | longer side with drop-front | 428 x 268 x 125/50 | 449 x 286 x 131 | MW 1.65 | grey-blue |
| 2110316 | longer side with drop-front | 428 x 268 x 125/50 | 449 x 286 x 131 | MW 1.7 | grey-blue |
| 3111016 | | 505 x 372 x 85/85 | 530 x 400 x 90 | FW 3.0 | light grey |
| | | | | | |
| | | | | | |
| | | | | | |
| | | | | | |
| | | | | | |
| | | | | | |
| | | | | | |
| | | | | | |
| | | | | | |
| | | | | | |
| | | | | | |
| | | | | | |
| | | | | | |
| | | | | | |
| | | | | | |
| | | | | | |
| | | | | | |
| | | | | | |
| | | | | | |
| | | | | | |
| | | | | | |

MW = corrugated board E-flute ; FW = corrugated board B-flute ; H = height ; H* 2nd H dimension is the lid height ; W = width ; T = thickness ; D = depth ; L = length

7. Boxes

7.7 Two-piece boxes

KS 16 with pull-strap and partition inserts

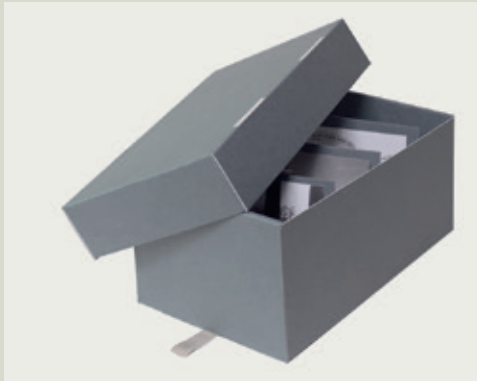

A two-piece box suitable for archiving postcards, index cards and microfiches. Made from corrugated board MW 1.7 mm, double-walled on two sides, very sturdy, smooth interior surfaces. A textile pull-strap is attached on the smaller side of the base of the box. Delivered with three loose, partition insert segments (dividers).

| Item | For size (cm) | 3 partitions L x W (cm) | Int. dimensions L x W x H/H* (mm) | Ext. dimensions L x B x H (mm) | Material (mm) | Colour (exterior) |
|-----------|-----------------------------|-------------------------|-----------------------------------|--------------------------------|---------------|-------------------|
| 216520516 | index cards 10.5 x 16 | 10.5 x 17 | 110 x 260 x 170/50 | 131 x 283 x 177 | MW 1.65 | grey-blue |
| 214787016 | index cards 10.5 x 16 | 10.5 x 17 | 110 x 260 x 170/50 | 131 x 283 x 177 | MW 1.7 | grey-blue |
| 216520716 | index cards 12 x 9.5 | 12 x 10 | 125 x 300 x 100/35 | 146 x 323 x 107 | MW 1.65 | grey-blue |
| 214789016 | index cards 12 x 9.5 | 12 x 10 | 125 x 300 x 100/35 | 146 x 323 x 107 | MW 1.7 | grey-blue |
| 216520616 | index cards 14 x 21.5 | 14 x 22 | 145 x 300 x 225/70 | 166 x 298 x 232 | MW 1.65 | grey-blue |
| 214788016 | index cards 14 x 21.5 | 14 x 22 | 145 x 300 x 225/70 | 166 x 298 x 232 | MW 1.7 | grey-blue |
| 216520316 | postcards 9 x 14, 10.5 x 15 | 15 x 12 | 155 x 275 x 120/50 | 176 x 283 x 127 | MW 1.65 | grey-blue |
| 214785016 | postcards 9 x 14, 10.5 x 15 | 15 x 12 | 155 x 275 x 120/50 | 176 x 283 x 127 | MW 1.7 | grey-blue |
| 216520416 | microfiches | 16 x 13 | 165 x 330 x 130/50 | 186 x 353 x 137 | MW 1.65 | grey-blue |
| 214786016 | microfiches | 16 x 13 | 165 x 330 x 130/50 | 186 x 353 x 137 | MW 1.7 | grey-blue |

MW = corrugated board E-flute ; FW = corrugated board B-flute ; H = height ; H* 2nd H dimension is the lid height ; W = width ; T = thickness ; D = depth ; L = length

7. Boxes

7.7 Two-piece boxes

KS 16 with tube insert

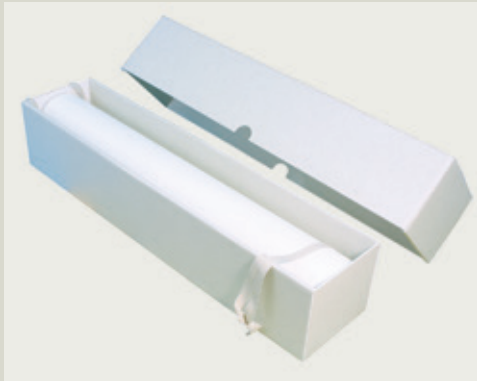

Roll storage boxes suitable for large-size and delicate archival objects (e.g. geographical/architectural maps, textiles etc.). The tube in the box is made from spirally wound conservation board and is supported by two layers of corrugated board. In this way absolutely no pressure is exposed on the stored object. Two textile ribbons enhance easy manoeuvrability of the tube. Delivery assembled and upright.

| Item | For size (cm) | Int. dimensions L x W x H (mm) | Ext. dimensions L x W x H (mm) | Material (mm) | Colour (exterior) |
|--------------|---------------|--------------------------------|--------------------------------|---------------|-------------------|
| upon request | | | | | |
| | | | | | |
| | | | | | |
| | | | | | |
| | | | | | |
| | | | | | |
| | | | | | |

7.8 Foldes boxes

for film reel storage

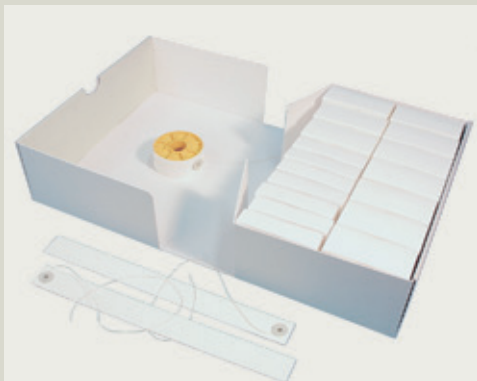

A clamshell box enclosing 14 or 26 small folded boxes – for storing 16 mm and 35 mm film reels. The small folded boxes are made from ageing-resistant, natural white coloured photographic archival board, 0.5 mm thick, without an alkaline buffer. The clamshell box itself is made from corrugated board, MW 1.6 mm.

| Item | Design (for film reels) | Int. dimensions H x W x T (mm) | Ext. dimensions H x W x T (mm) | Material/thickness (mm) | Colour (exterior) |
|-----------|-------------------------|--------------------------------|--------------------------------|----------------------------------|-------------------|
| 642589 | 16 mm film reel | 100 x 100 x 25 | 102 x 102 x 26 | photographic archival board, 0.5 | natural white |
| 642689 | 35 mm film reel | 100 x 100 x 45 | 102 x 102 x 46 | photographic archival board, 0.5 | natural white |
| 652789 | 16 mm, 35 mm reel | 330 x 207 x 104 | 345 x 221 x 109 | MW 1.6 | light grey |
| 216513603 | 16 mm, 35 mm reel | 330 x 207 x 104 | 345 x 221 x 109 | MW 1.65 | grey-blue |
| | | | | | |
| | | | | | |
| | | | | | |

MW = corrugated board E-flute ; FW = corrugated board B-flute ; H = height ; H* 2nd H dimension is the lid height ; W = width ; T = thickness ; D = depth ; L = length

7. Boxes

7.9 Box configurator

Custom-made boxes

Based on our modular design concept you can configure your individual box. Our inventory allows for a variety of combination possibilities. You will find the configurator at klug-conservation.com > Products > Boxes

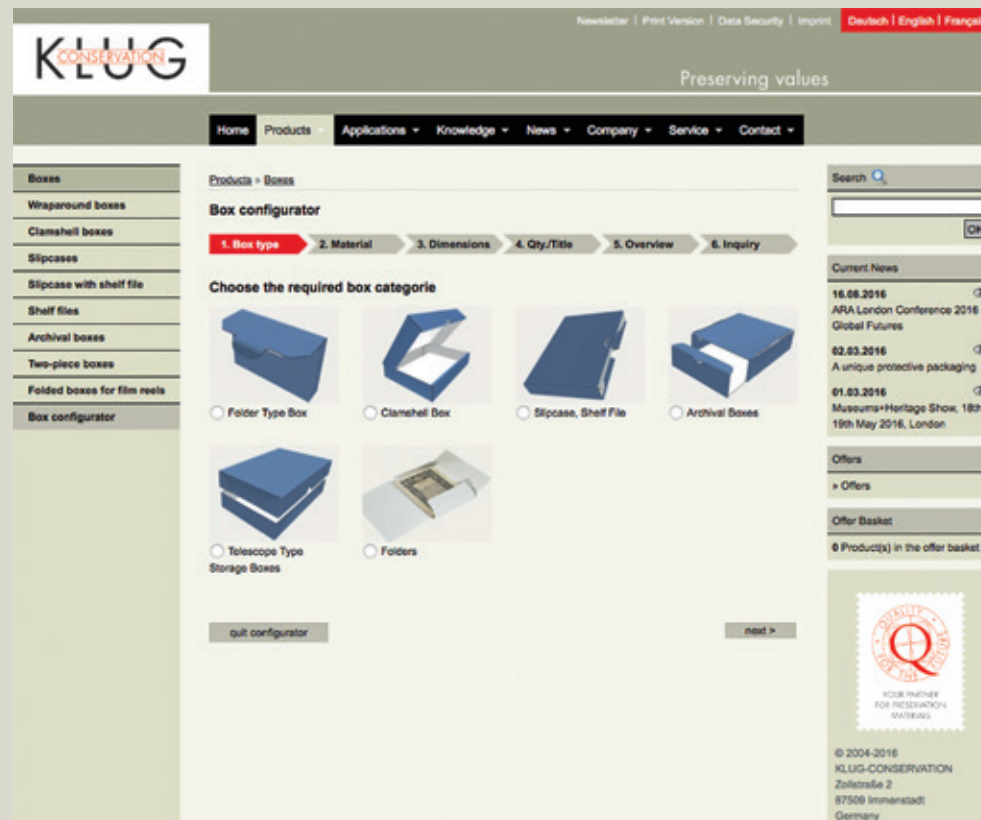

box configurator

8. Tubes

8.1 Tubes

made from conservation board

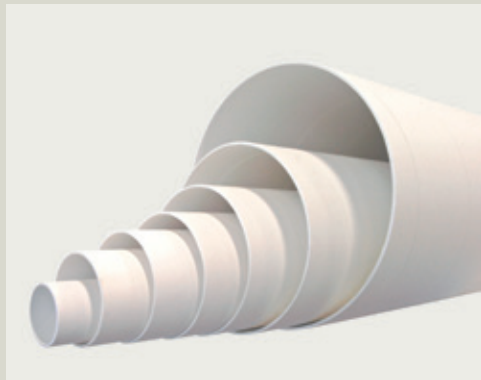

Tubes made from spiral-wound, natural white, ageing-resistant conservation board. Board plies are glued with a quality tested lamination glue, pH-neutral and free of softening agents. Cutting to customer size on request, tubes available in various diameter sizes and can be cut to a max. length of 10 m. Tube inserts (joining segments) are also available to extend the lengths of 150/200 mm diameter tubes to a max. of 4200 mm.

| Item | Wall thickness (mm) | Tube diameter (Ø mm) | Length ¹⁾ (mm) | Tube or insert per unit | Colour |
|----------|---------------------|----------------------|---------------------------|-------------------------|---------------|
| 01911101 | 2.0 | 100 | 2100 | 1 tube | natural white |
| 01911121 | 2.0 | 120 | 2100 | 1 tube | natural white |
| 01911145 | 2.5 | 145 | 500 | 1 tube insert | natural white |
| 01911151 | 2.0 | 150 | 2100 | 1 tube | natural white |
| 01911190 | 5.0 | 190 | 500 | 1 tube insert | natural white |
| 01911201 | 2.5 | 200 | 2100 | 1 tube | natural white |
| 01911301 | 3.0 | 300 | 2500 | 1 tube | natural white |

Shts. = sheets ; unit = packaging unit ; ¹⁾ cuttings to size, extra cost ; ²⁾ cuttings not possible ; ³⁾ without 4-sided angular cut ; ⁴⁾ units packed in poly bags

9. Glues/Tapes

9.1 Dispersion glues



| Item | Weight (kg) | Qty./unit | Colour |
|------|-------------|---------------|--------|
| 0199 | 0.5 | 1 plastic jar | white |
| 0200 | 0.5 | 1 plastic jar | white |
| | | | |
| | | | |
| | | | |
| | | | |
| | | | |
| | | | |
| | | | |

Dispersion glues made on an aqueous basis. Manufactured free of softening agents and pH-neutral. Suitable for either manual or machine book-binding and lamination work.

The glues have been especially developed for long-term preservation and archival storage of photographic items.

9.1 Tylose MH300



| Item | Weight (ml) | Qty./unit | Colour |
|------|-------------|-----------|-------------|
| 0203 | 40 | 1 tube | transparent |
| | | | |
| | | | |
| | | | |
| | | | |
| | | | |
| | | | |
| | | | |
| | | | |

A suitable glue for file preparation (treatment), mounting of objects and other applications in the conservation and preservation fields. From the conservation point-of-view, the cellulose derivative „Tylose MH300“ (methyl hydroxyethyl cellulose) is a totally harmless and reversible glue. This biopolymer is usually utilized in the field of paper conservation. It is physiologically harmless and water-soluble. Micro-organisms can affect this adhesive with great difficulty.

Unit = packaging unit

9. Glues/Tapes

9.2 Tapes

made from paper



Paper tape made on the basis of potato starch and manufactured without the usage of softeners or plasticizers. Used for the manufacture of conservation-quality mats, mounts, file and preservation folders in the picture framing industry. Free of acidic substances.

| Item | Reel width (cm) | Running metres ¹⁾ (m) | Weight (gsm) | pH value | Reel/unit | Colour |
|----------|-----------------|----------------------------------|--------------|-------------|-----------|--------|
| 067-25/0 | 2.5 | 50 | approx. 70 | approx. 7.0 | 1 | white |
| 067-50/0 | 5.0 | 50 | approx. 70 | approx. 7.0 | 1 | white |
| | | | | | | |
| | | | | | | |
| | | | | | | |
| | | | | | | |

9.2 Tapes

made from fabric



Starch-based fabric tape manufactured without the usage of softeners or plasticizers. Used for the manufacture of conservation-quality mats, mounts, file and preservation folders in the picture framing industry. Free of acidic substances. Grammage of the fabric tape including the adhesive coating is approx. 170 gsm.

| Item | Reel width (cm) | Running metres ¹⁾ (m) | Weight (gsm) | pH value | Reel/unit | Colour |
|--------|-----------------|----------------------------------|--------------|---------------|-----------|---------------|
| 089-23 | 3.0 | 50 | 170 | 7.0 – neutral | 1 | natural white |
| 089-24 | 4.0 | 50 | 170 | 7.0 – neutral | 1 | natural white |
| 089-25 | 5.0 | 50 | 170 | 7.0 – neutral | 1 | natural white |
| 089-26 | 6.0 | 50 | 170 | 7.0 – neutral | 1 | natural white |
| | | | | | | |
| | | | | | | |

Shts. = sheets ; unit = packaging unit ; ¹⁾ cuttings to size, extra cost ; ²⁾ cuttings not possible ; ³⁾ without 4-sided angular cut ; ⁴⁾ units packed in poly bags

10. Accessories

10.1 Label paper



White coloured, conservation-quality label paper with a dextrin-based gumming. Labels are available in A4 size (one A4 sheet) as well as many other sizes (micro-perforated A4 sheets). Suitable for printing using laser, inkjet, needle, thermo-transfer printers as well as for offset print. Size, format and print colour of each label can be customized according to individual requirements. The label can be mounted with ease by activating the gummed backside with moisture.

| Item | Weight (gsm) | Size of cutting (cm) | Label size H x W (mm) | Labels/cutting | Cuttings (shts.)/unit | Colour |
|----------|--------------|-------------------------|-----------------------|----------------|-----------------------|--------|
| 00991057 | 105 | 21 x 29.7 ²⁾ | A4 sht. 10 x 60 | 78 | 100 A4 (7800 labels) | white |
| 00991053 | 105 | 21 x 29.7 ²⁾ | A4 sht. 22 x 62 | 36 | 100 A4 (3600 labels) | white |
| 00991055 | 105 | 21 x 29.7 ²⁾ | A4 sht. 25 x 91 | 20 | 100 A4 (2000 labels) | white |
| 00991056 | 105 | 21 x 29.7 ²⁾ | A4 sht. 30 x 30 | 48 | 100 A4 (4800 labels) | white |
| 00991058 | 105 | 21 x 29.7 ²⁾ | A4 sht. 33 x 50 | 32 | 100 A4 (3200 labels) | white |
| 00991051 | 105 | 21 x 29.7 ²⁾ | A4 sht. 33 x 90 | 16 | 100 A4 (1600 labels) | white |
| 00991061 | 105 | 21 x 29.7 ²⁾ | A4 sht. 35 x 65 | 24 | 100 A4 (2400 labels) | white |
| 00991052 | 105 | 21 x 29.7 ²⁾ | A4 sht. 139.7 x 78.7 | 4 | 100 A4 (400 labels) | white |
| 00991054 | 105 | 21 x 29.7 | A4 sht. 297 x 210 | 1 | 500 A4 (500 labels) | white |
| | | | | | | |
| | | | | | | |
| | | | | | | |
| | | | | | | |
| | | | | | | |
| | | | | | | |
| | | | | | | |
| | | | | | | |
| | | | | | | |
| | | | | | | |
| | | | | | | |
| | | | | | | |
| | | | | | | |
| | | | | | | |
| | | | | | | |
| | | | | | | |
| | | | | | | |
| | | | | | | |

Shts. = sheets ; unit = packaging unit ; ¹⁾ cuttings to size, extra cost ; ²⁾ cuttings not possible ; ³⁾ without 4-sided angular cut ; ⁴⁾ units packed in poly bags ; ⁵⁾ extra cost for freight & packaging

10. Accessories

10.2 Signature labels



| Item | Design | Colour |
|------|------------------------------|--------|
| 1021 | make signature labels | white |
| 1023 | cut and gum signature labels | white |
| | | |
| | | |
| | | |
| | | |
| | | |
| | | |
| | | |
| | | |
| | | |
| | | |

Signature labels are made from ageing-resistant label paper of conservation-quality. Each individual label is laser printed. We not only label individual boxes, file folders and enclosures, but on request we can have the similar labels printed (offset or silk-screen print) and brought onto any desired KLUG product.

10. Accessories

10.3 Label frames



The main advantage of these label frames (holder) made from archival board is that the inscription can be easily removed or replaced and thus very user-friendly. The frame label can be brought on to any desired position.

Custom-made frame sizes available on request.

| Item | Design | Int. dimensions window size (mm) | Ext. dimensions (mm) | Material, weight (gsm) | Colour |
|---------|------------------|----------------------------------|----------------------|------------------------|------------|
| 0099081 | opening edgewise | 15 x 50 | 35 x 70 | archival board, 240 | light grey |
| 0099087 | opening edgewise | 15 x 50 | 35 x 70 | archival board, 330 | grey-blue |
| 0099091 | opening edgewise | 35 x 70 | 55 x 90 | archival board, 240 | light grey |
| 009909 | opening edgewise | 35 x 70 | 55 x 90 | archival board, 330 | light grey |
| 0099097 | opening edgewise | 35 x 70 | 55 x 90 | archival board, 330 | grey-blue |
| 0099111 | opening edgewise | 40 x 80 | 60 x 100 | archival board, 240 | light grey |
| 009911 | opening edgewise | 40 x 80 | 60 x 100 | archival board, 330 | light grey |
| 0099117 | opening edgewise | 40 x 80 | 60 x 100 | archival board, 330 | grey-blue |
| 0099101 | opening edgewise | 40 x 120 | 60 x 140 | archival board, 240 | light grey |
| 009915 | opening edgewise | 40 x 120 | 60 x 140 | archival board, 330 | grey-blue |
| 009916 | opening edgewise | 40 x 120 | 60 x 140 | archival board, 330 | light grey |
| | | | | | |
| | | | | | |
| | | | | | |
| | | | | | |
| | | | | | |
| | | | | | |
| | | | | | |
| | | | | | |
| | | | | | |
| | | | | | |
| | | | | | |
| | | | | | |
| | | | | | |
| | | | | | |
| | | | | | |

Shts. = sheets ; unit = packaging unit ; ¹⁾ cuttings to size, extra cost ; ²⁾ cuttings not possible ; ³⁾ without 4-sided angular cut ; ⁴⁾ units packed in poly bags ; ⁵⁾ extra cost for freight & packaging

10. Accessories

10.4 Mounting accessories

Mounting corners

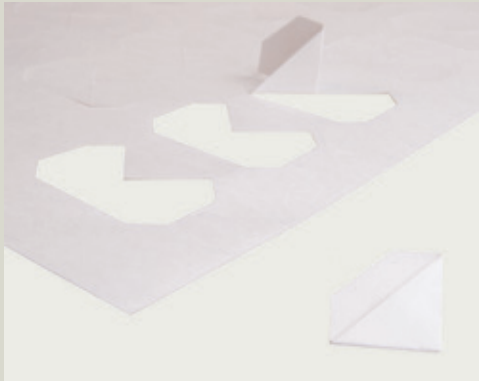

Mounting corners used for mounting photographs, graphics and other flat originals. Made of unbuffered photographic archival paper, 120 gsm, without the usage of optical brightening agents. Cutting size 25 x 35 cm with 36 mounting corners, not broken off! Packed in plastic polythene bags.

| Item | Weight (gsm) | Size of cutting ²⁾ (cm) | Size of corner (mm) | Corners/cutting ²⁾ | Shts./unit (corners) | Colour |
|---------|--------------|------------------------------------|---------------------|-------------------------------|----------------------|---------------|
| 9411140 | 120 | 25 x 35 | 20 x 27 | 36 | 10 (360 corners) | natural white |
| | | | | | | |
| | | | | | | |
| | | | | | | |
| | | | | | | |
| | | | | | | |

10.4 Mounting accessories

Mounting segments for seals



Mounting segments used to affix legal documents with attached or hanging pendant seals. Circular and angular segments - made of ageing resistant board – are most commonly used for mounting flat documents. The segments are glued either flush or offset, mounted above each other. This enables the fixation of various types of seal forms or legal documents onto flat documents without causing any damage.

| Item | For size (mm) design | Material (mm) | Segments/ cutting | Cuttings/ unit | Colour |
|---------|--|---------------|-------------------|----------------|--------------------------|
| 9411100 | circular segment: 27 x 96 x 12 | MW 1.8 | 12 | 5 (60 pieces) | light grey/natural white |
| 9411110 | circular segment: 4 different radiuses | MW 1.8 | 72 | 5 (360 pieces) | light grey/natural white |
| 9411120 | circle diameter: 30 | MW 1.8 | 20 | 5 (100 pieces) | light grey/natural white |
| 9411130 | angular segment: 35 x 35 | MW 1.8 | 20 | 5 (100 pieces) | light grey/natural white |
| | | | | | |
| | | | | | |

Photograph: City Frankfurt / Main – Institute for Municipal History – Mrs. Jana Moczarski

Shts. = sheets ; unit = packaging unit ; ¹⁾ cuttings to size, extra cost ; ²⁾ cuttings not possible ; ³⁾ without 4-sided angular cut ; ⁴⁾ units packed in poly bags

10. Accessories

10.5 Polyester nonwoven fabric

on rolls, thermally bonded



Polyester nonwoven fabric roll, 30 gsm, thermally bonded, air-permeable, chemically inert with an extremely smooth surface finish. The support fabric can be used in many different types of preservation and restoration work, e.g. to support fragile items during conservation treatments, as a release material in wet processes (carrier-support while soaking items in water) and as interleaving material.

| Item | Weight | Roll width (gsm) | Running metres (cm) | Material (m) | Roll/unit | Colour |
|---------|--------|------------------|---------------------|----------------|-----------|--------|
| 9411903 | 30 | 100 | 50 | 100% polyester | 1 | white |
| | | | | | | |
| | | | | | | |
| | | | | | | |
| | | | | | | |
| | | | | | | |

10.6 Filing mechanisms



Filing mechanisms made of polyamide plastic for usage in folders and pre-punched file/folders enclosures. The filing mechanism is made of 100% polyamide plastic material, light grey in colour, is free of plasticizers and other softening agents, possesses high tensile strength and is ageing resistant. You can easily browse the filed contents, stack up if necessary, scroll and photocopy.

| Item | For size | Material | Qty./unit | Colour |
|--------|-------------------|----------------|-----------|------------|
| 900199 | spine depth 95 mm | 100% polyamide | 1000 | light grey |
| | | | | |
| | | | | |
| | | | | |
| | | | | |
| | | | | |

Shts. = sheets ; unit = packaging unit ; ¹⁾ cuttings to size, extra cost ; ²⁾ cuttings not possible ; ³⁾ without 4-sided angular cut ; ⁴⁾ units packed in poly bags

10. Accessories

10.7 Albertina poultice



| Item | Size ¹⁾ (cm) | Sets/unit | Colour |
|---------|-------------------------|-----------|--------|
| 0512030 | 20 x 30 | 1 | white |
| 0512040 | 29 x 39 | 1 | white |
| | | | |
| | | | |
| | | | |
| | | | |
| | | | |
| | | | |
| | | | |
| | | | |
| | | | |

This enzyme poultice is a ready-for-use product for the easy removal of non-swellable starch-based (amylase) glue.

The set is available in a plastic pocket bag and comprises of two interleaving tissue papers, an amylase poultice and a moistening fleece (blotting board).

Please pay particular attention to the application instructions.

10.8 Panduran pen



| Item | Design | Pens/unit | Colour |
|------|--------|-----------|--------|
| 11-1 | pen | 1 | white |
| | | | |
| | | | |
| | | | |
| | | | |
| | | | |
| | | | |
| | | | |
| | | | |
| | | | |
| | | | |

Since the 19th century machine-made paper and board material was generally sized with alum. This has been the main reason for the premature decay of paper. Panduran is an eriochrome dye which reacts chemically to the aluminium ions present in alum, and in the process changes from yellow to blue to violet, thus detecting the alum content in the paper being tested. This reaction is not influenced by the pH of the tested paper. Boards and papers with alum content are principally not suitable for long-term archival storage.

Shts. = sheets ; unit = packaging unit ; ¹⁾ cuttings to size, extra cost ; ²⁾ cuttings not possible ; ³⁾ without 4-sided angular cut ; ⁴⁾ units packed in poly bags

11. Boxing System

11.1 Boxing system

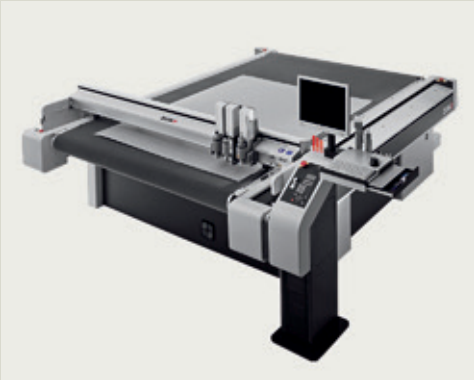

A complete boxing system to produce custom-made boxes, cases, folders and other types of protective packagings especially for cultural artefacts.

All components of this system including the KLUG board and paper material supplement each other and are optimized for the individual requirements of libraries, archives and museums. The main components of the boxing system are: one or more book measuring devices, a digital cutter, CAD/CAM software to design the products.

We offer financial possibilities to either lease or purchase the boxing system.

Please contact our sales team for more information.

Storage conditions of paper and board



Recommended storage instructions

Paper and board are materials possessing hygroscopic properties. That means they can either absorb or release moisture from the atmospheric surroundings. Hygroscopic materials are constantly trying to compensate moisture differences between the surrounding ambient air. This is a never-ending dynamic process.

Since the relative humidity depends upon the prevailing weather conditions, there are often strong fluctuations. These weather fluctuations have a significant influence on storage conditions especially in non-temperature-conditioned storage rooms.

KLUG products are produced and stored under controlled environmental conditions with a constant relative humidity between 45 and 60%. In the case of large temperature variations between the material and ambient air there is a great risk of the material warping, shrinking or in fact even increasing. (Size and format difference up to several mm possible!)

Recommended storage conditions

- Temperature 18 – 20 °C (64.4 – 68 °F)
- Relative humidity 50 – 55%

For further information regarding storage conditions of paper and board please refer to our website klug-conservation.com.

Sales terms and conditions

Prices: We offer subject to confirmation (subject to revision without notice) exclusive of VAT (net value). VAT is chargeable to E. C. customers, unless your VAT-Number is supplied to us. VAT at the current rate is to be charged by law on the total cost of goods and carriage. Exports outside the European Community are not subject to VAT. Excluding other indirect taxes and custom charges.

Delivery terms: Multimodal transport, depending on net order value and measurement of your shipment. Freight prices upon request.

Parcel terms: Prices are subject to weight of the parcel (UPS, DHL or FedEx), price inquiries upon request.

Delivery instructions: Please inspect your package immediately upon delivery. In case of any visible damage, please make a note of it on the freight document and have it confirmed by the haulage driver before signing the receipt document. This allows us to claim compensation for damages from our transport insurance. If the ordered goods are delivered by a shipping company, the consignee is responsible for unloading the goods (parcels/pallets) from the truck. If this is not possible, for example in the case of pallet delivery because neither a forklift nor pallet truck are available, please inform us prior to placing the order – we will surely find a solution for you!

Payment terms: 14 days 2% discount, 30 days net plus VAT – as of invoice date.

New customers; first delivery payment with order (C.W.O.)

Packaging cost:

- inclusive if net order value of goods is more than 500 €, excluding packaging for bulky goods
- parcel package minimum 8.00 €
- bale package minimum 8.00 €
- pallet package minimum 25.00 €

Place of performance and jurisdiction is Immenstadt in Allgäu/Germany. Otherwise we refer to our "General business terms and conditions".

1 May 2019

KLUG-CONSERVATION
Walter Klug GmbH & Co. KG
Zollstrasse 2
87509 Immenstadt/Germany

Telephone +49 (0)8323 9653 30
Telefax +49 (0)8323 9653 399 30
info@klug-conservation.com
www.klug-conservation.com